

La flessibilità che non ti aspetti



Arda's research has led to the development of Elastika®, an innovative range of technical drawing equipment made using a material offering a major advantage: the ability to bend and revert to its original shape without suffering any damage. It guarantees genuine technical drawing tools, combining flexibility with other essential features: transparency, undeformability and precision measurement.

The real difference that make Elastika® unique and inimitable.

Le département de recherche d'ARDA a donné naissance à Elastika®, une gamme innovante d'instruments de dessin technique réalisée dans une matière qui permet un résultat extraordinaire: la capacité de se plier et de revenir à sa forme originale sans se déformer est la certitude d'avoir en main un instrument qui allie la souplesse aux autres caractéristiques essentielles : transparence, stabilité de la forme et précision de la mesure.

La vraie différence qui fait de Elastika® une gamme unique et inimitable.

Dalla ricerca Arda è nata Elastika®, innovativa linea per il disegno. **L'unica che puoi piegare ma torna sempre in forma, senza spezzarsi nè rovinarsi** e con la garanzia di utilizzare un vero e proprio strumento da disegno tecnico, che abbina la flessibilità alle altre caratteristiche essenziali: trasparenza, stabilità di forma e precisione delle misure. **Queste le vere differenze che rendono Elastika® unica e inimitabile.**

MADE IN ITALY



ITALIAN QUALITY & STYLE

Squadre 45° e 60°

Set square 45° and 60°
Equerre 45° et 60°

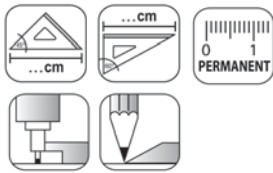

Smusso, tirachina e bordo interno
Bevelled edge, ink-edge and finger lift
Facette, bord anti-tache et bord intérieur



Ref. EL4520 - 30 - 35

Art.	EAN13 art.	Descrizione / Description	INNER pcs	EAN13 inner	MASTER pcs
EL4520	8003438012562	45° cm. 20	10	8003438012579	300
EL4530	8003438011091	45° cm. 30	10	8003438012036	220
EL4535	8003438011114	45° cm. 35	10	8003438012050	140

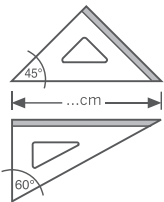

**PUNTE
ARROTONDATE
DI SICUREZZA**

**ROUND EDGES
FOR SECURITY**

**BOUTS ROUNDS POUR
PLUS DE SÉCURITÉ**



Ref. EL6020 - 30 - 35

Art.	EAN13 art.	Descrizione / Description	INNER pcs	EAN13 inner	MASTER pcs
EL6020	8003438012593	60° cm. 20	10	8003438012609	320
EL6030	8003438011107	60° cm. 30	10	8003438012043	200
EL6035	8003438011121	60° cm. 35	10	8003438012067	100

Righe

Rulers
Règles

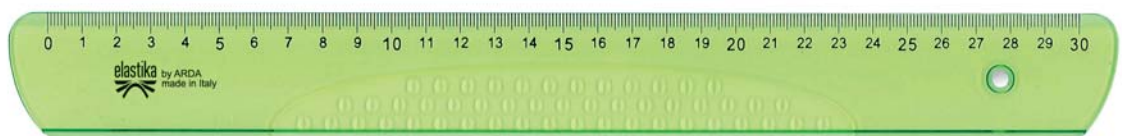

Ref. EL30-50-60



Smusso e tirachina
Bevelled edge and ink-edge
Facette et bord anti-tache



Art.	EAN13 art.	Descrizione / Description	INNER pcs	EAN13 inner	MASTER pcs
EL30	8003438011138	cm. 30	10	8003438012074	300
EL50	8003438011152	cm. 50	10	8003438012081	200
EL60	8003438013453	cm. 60	10	8003438013460	150

Righelli 15 cm

Rulers 15 cm
Règle 15 cm



Smusso
Bevelled edge
Facette



20
pcs

Ref. EL15ESP
11,7x10,1x25 h. cm

SMUSSO "INTELLIGENTE" PER SOLLEVARE FACILMENTE IL RIGHELLO DAL FOGLIO

"SMART" BEVEL TO EASILY LIFT THE RULER FROM THE SHEET

BISEAU "INTELLIGENTE" POUR PRISE EN MAIN FACILE DE LA RÈGLE



Ref. EL15

Art.	EAN13 art.	Descrizione / Description	INNER pcs	EAN13 inner	MASTER pcs
EL15	8003438018014	Righello Elastika cm.15	10	8003438018021	10
EL15ESP	8003438017963	Display 20 righelli cm.15 (art. sing. 8003438 018014)	1	8003438017963	1

Doppi e Tripli decimetri

Finger grip ruler 20-30cm
Double e triple décimètre

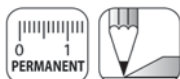

2 millimetrature. Impugnatura corta
2 graduations. Short grip
2 graduations. Poignée courte

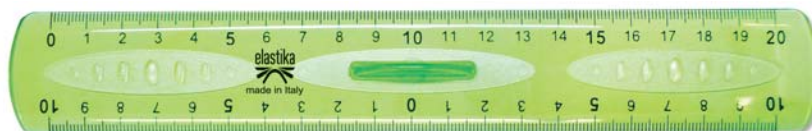

Ref. EL20P



Ref. EL30P

Art.	EAN13 art.	Descrizione / Description	INNER pcs	EAN13 inner	MASTER pcs
EL20P	8003438011176	cm. 20	10	8003438012098	200
EL30P	8003438011213	cm.30	10	8003438012104	240

Goniometro 180°

Protractor 180°
Rapporteur 180°

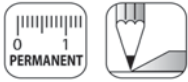

Smusso e bordo interno
Bevelled edge and finger lift
Facette et bord intérieur

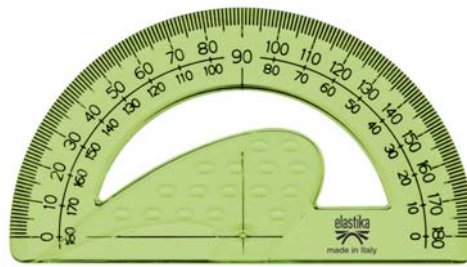

Ref. EL18012



Art.	EAN13 art.	Descrizione / Description	INNER pcs	EAN13 inner	MASTER pcs
EL18012	8003438011404	180° cm. 12	10	8003438012111	200

Goniometro 360°

Protractor 360°
Rapporteur 360°

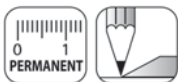

Smusso e bordo interno
Bevelled edge and finger lift
Facette et bord intérieur

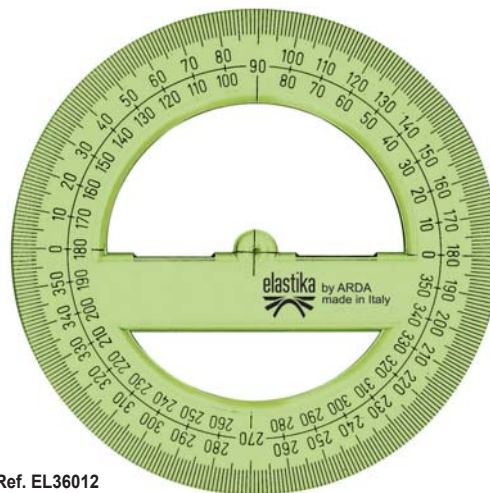

Ref. EL36012



Art.	EAN13 art.	Descrizione / Description	INNER pcs	EAN13 inner	MASTER pcs
EL36012	8003438011411	360° cm. 12	10	8003438012128	360

Squadra geometrica

Geometric square
Equerre géométrique

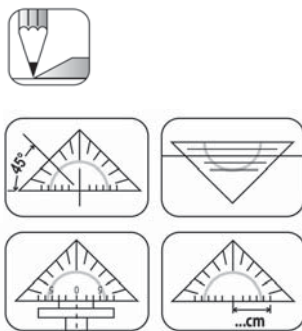

4 FUNZIONI IN 1 - 4 FUNCTIONS IN 1 - 4 USAGES EN 1

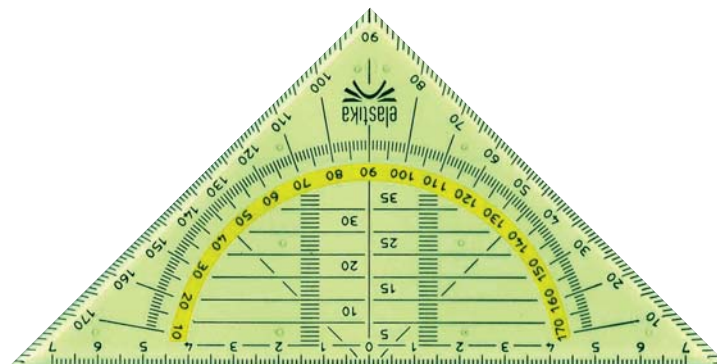

Ref. ELGEO300



Art.	EAN13 art.	Descrizione / Description	INNER pcs	EAN13 inner	MASTER pcs
ELGEO300	8003438016140	Geo300 - 45° cm. 16	20	8003438016157	400

Espositori da banco in cartone

Carton desktop displays - Présentoirs de comptoir en carton



Contenuto specifico per disegno tecnico su fogli A3
 Specific content for technical drawing on A3 sheets
 Contenu spécifique pour le dessin technique sur papier A3



Contenuto specifico per disegno tecnico su fogli A4
 Specific content for technical drawing on A4 sheets
 Contenu spécifique pour le dessin technique sur papier A4



61 pcs

Ref. EL4766
 32,5 x 25 x 57 h. cm



90 pcs

Ref. EL4765F
 32,5 x 25 x 51 h. cm

DISPLAY 61 pz / pcs

Art.	EAN13 art.	Descrizione / Description	INNER	MASTER
EL4766	8003438 017987	10x Sq. 45°cm.30 - ref.EL4530 10x Sq. 60°cm.30 - ref. EL6030 1x display 20 righelli cm.15 - ref.EL15ESP 10x Righe cm. 50 - ref. EL50 10x Doppio dec. - ref. EL20P 10x Triplo dec. - ref. EL30P 10x Gon. 360°cm.12 - ref.EL36012	1	1

Disponibilità limitata alle campagne promozionali - Product availability limited to promotional campaigns - Disponibilité limitée aux campagnes promotionnelles

DISPLAY 90 pz / pcs

Art.	EAN13 art.	Descrizione / Description	INNER	MASTER
EL4765F	8003438 013781	10x Sq. 45°cm.20 - ref. EL4520 20x Sq. 60°cm.20 - ref. EL6020 10x Righe cm.30 - ref. EL30 20x Doppio dec. - ref. EL20P 10x Triplo dec. - ref. EL30P 20x Gon. 180°cm.12 - ref.EL18012	1	1

Disponibilità limitata alle campagne promozionali - Product availability limited to promotional campaigns - Disponibilité limitée aux campagnes promotionnelles

Espositori da terra in cartone

Carton floor displays - Presentoirs au sol en carton

DISPLAY 200 pz / pcs

Art.	EAN13 art.	Descrizione / Description	INNER	MASTER
500EL	8003438 032799	40x Sq. 45°cm.30 - ref.EL4530 40x Sq. 60°cm.30 - ref. EL6030 40x Righe cm. 30 - ref. EL30 40x Righe cm. 50 - ref. EL50 40x Gon. 360°cm.12 - ref.EL36012	1	1

Disponibilità limitata alle campagne promozionali - Product availability limited to promotional campaigns - Disponibilité limitée aux campagnes promotionnelles

200
pcs

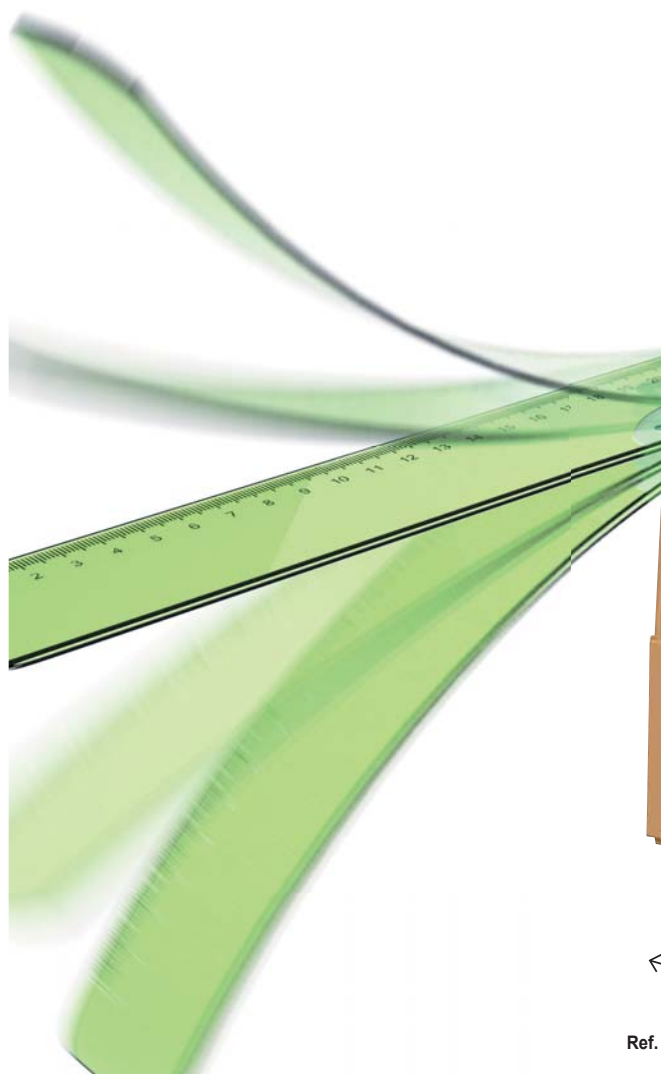

Ref. 500EL

Corredo per disegno Elastika

Set for school Elastika - Kit de traçage Elastika

Per custodire tutto il necessario per il disegno tecnico !

To bring to school and protect everything you need for technical drawing !

Pour apporter à l'école et garder tout ce dont vous avez besoin pour le dessin technique !

Tecniko

DISEGNO
DRAWING



Contenuto - Content - Contenu :



* Album disegno non incluso - Drawing album not included - Papier à dessin non inclus

Art.	EAN13 art.	INNER pcs	EAN13 inner	MASTER pcs
AST01	8003438030665	1	8003438030665	1

IN SCATOLA REGALO - GIFT BOX - EN COFFRET CADEAU

Valigetta Elastika

Big briefcase with ruler pocket - Mallette avec pochette pour règle



EXTRA SIZE
cm.52 x 37



ref.EL5237

TESSUTO INNOVATIVO IN r-PET

molto robusto ma allo stesso tempo leggero e pratico da pulire.
Cuciture e chiusure super resistenti

NEW MATERIAL r-PET

very robust fabric but at the same time light and practical to clean.
Super resistant seams and closures.

TISSU INNOVANT r-PET

très robuste mais à la fois léger et pratique à nettoyer. Coutures et fermetures super résistantes



TASCA PORTARIGA 50 / 60 cm.

**INSIDE POCKET FOR RULER
POCHE POUR REGLE**

Art.	EAN13 art.	INNER pcs	EAN13 inner	MASTER pcs
EL5237	8003438032478	2	8003438032485	24

Balaustrone con frizione e prolunga

Quick-set compass with push button and arm

Balustre avec réglage rapide et rallonge

Aste con finitura satinata - Rods with satin finish - Branches avec finition satinée



ASTUCCIO STAND-UP : protegge il compasso e tutti gli accessori. lo apri, lo pieghi e hai tutto a portata di mano !

STAND-UP FABRIC CASE : save your compass and accessories. open it, fold it and you have everything at your fingertips !

STAND-UP CASE : protège la boussole et tous les accessoires. vous l'ouvrez, vous le pliez et vous avez tout à portée de main !

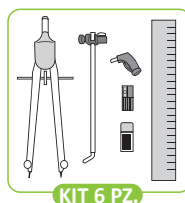

KIT 6 PZ.



Ref. CO1EL

Art.	EAN13 art.	Descrizione / Description	INNER	EAN13 inner	MASTER
CO1EL	8003438030672	BALAUSTRONE con frizione e prolunga - kit 6 pz	3	8003438030689	3

Tubo portadisegni

nylon tubes for drawings - tubes pour dessins en nylon

In nylon impermeabile. Tracolla regolabile, maniglia e chiusura con zip.

In waterproof nylon. Adjustable shoulder strap, handle and zip closure.

En nylon imperméable. Bandoulière réglable, poignée et fermeture zippée.



IN NYLON



ref. 1572S



Art.	EAN13 art.	Descrizione / Description	INNER	EAN13 inner	MASTER
1572S	8003438030856	TUBO PORTADISEGNI ELASTIKA col. ass. (4 neri / black / noir + 2 verdi / green / vert)	6	8003438030863	6

METARIGA°

ARDA



semplicemente
geniale!

The ingenious solution that solves the problem of lines sticking out of backpacks and briefcases !

It is precise and maintains all the technical characteristics of a traditional ruler. Protection case.

La solution ingénieuse qui résout le problème des lignes qui dépassent des sacs à dos et des porte-documents !

Précis, conserve les caractéristiques techniques d'une règle traditionnelle inchangées. Emballé dans un étui protective.

La soluzione geniale che risolve il problema delle righe che fuoriescono da zaini e cartelle !

E' precisa e mantiene inalterate tutte le caratteristiche tecniche di una riga tradizionale. Confezionata in custodia protettiva.

MADE IN ITALY



ITALIAN QUALITY & STYLE

Riga cm.60 pieghevole

Folding ruler cm.60
Règle pliable cm.60

Si piega a metà!

60 cm in metà spazio

DISEGNO DRAWING



12
pcs

**ASTUCCIO
SOFT
TOUCH**



Ref. MET60ESP
30 x 11 x 48 h. cm

Ref. MET60SS

Disponibile in display 12 pz (ref.MET60ESP) o in scatola da 6 pz come ricarica (ref.MET60SS)
Available in display 12 pcs (ref.MET60ESP) or box 6 pcs as refill (ref.MET60SS)
Disponibile en display 12 pcs (ref.MET60ESP) ou en carton 6 pcs en recharge (ref.MET60SS)

Art.	EAN13 art.	Descrizione / Description	INNER pcs	EAN13 inner	MASTER pcs
MET60ESP	8003438030702	Espositore 12 pz METARIGA cm.60 (ean pz 8003438 028174)	1	8003438030702	1
MET60SS	8003438028174	METARIGA - Riga cm.60 pieghevole in scatola	6	8003438030696	6

Isotek

ARDA

PER IL DISEGNO TECNICO PROFESSIONALE



FOR PROFESSIONAL TECHNICAL DRAWING

Specific line for technical drawing. Is injected in PLEXIGLAS® material, strong and extra transparent. The graduation is etched and indelible.

POUR LE DESSIN TECHNIQUE PROFESSIONNEL

Gamme de traçage pour le dessin technique. La matière employé est le PLEXIGLAS®, très résistante et de haute transparence. La gravure de la graduation est indélébile.

É la serie di precisione per il disegno tecnico professionale. Il materiale impiegato è il PLEXIGLAS®, resistente agli urti e ai graffi e di massima trasparenza. La graduazione è incisa ed indelebile.

**PROFESSIONAL
HIGH QUALITY**

MADE IN ITALY

ITALIAN QUALITY & STYLE

MATERIALE ACRILICO
® plexiglas

Squadre

Set square - Equerre



Smusso, tirachina e bordo interno
Bevelled edge, ink-edge and finger lift
Facette, bord anti-tache et bord intérieur

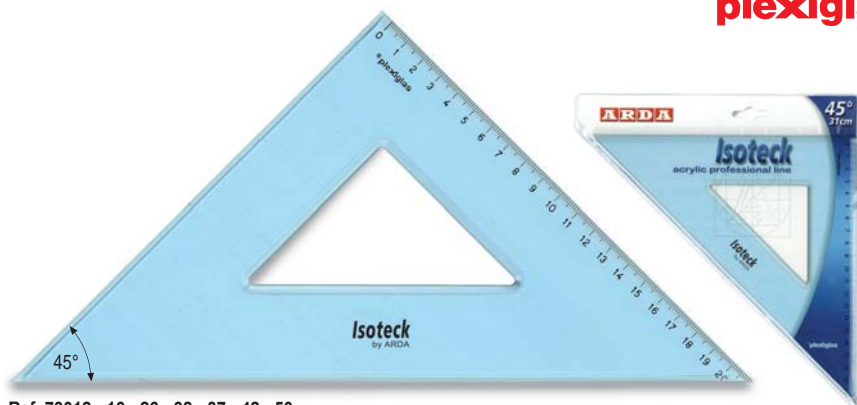

Ref. 73012 - 16 - 26 - 32 - 37 - 42 - 50

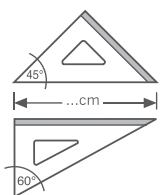

Art.	EAN13 art.	Descrizione / Description	INNER pcs	EAN13 inner	MASTER pcs
73012	8003438730121	45° cm. 12	10	8003438732125	10
73016	8003438730169	45° cm. 16	10	8003438732163	10
73026	8003438730268	45° cm. 26	10	8003438732262	10
73032	8003438730329	45° cm. 31	10	8003438732323	10
73037	8003438730374	45° cm. 36	10	8003438732378	10
* 73042	8003438730428	45° cm. 42	1	8003438730428	10
* 73050	8003438730503	45° cm. 50	1	8003438730503	10

* Ricavate da lastra
Cut from plate
Découpé à partir de la plaque

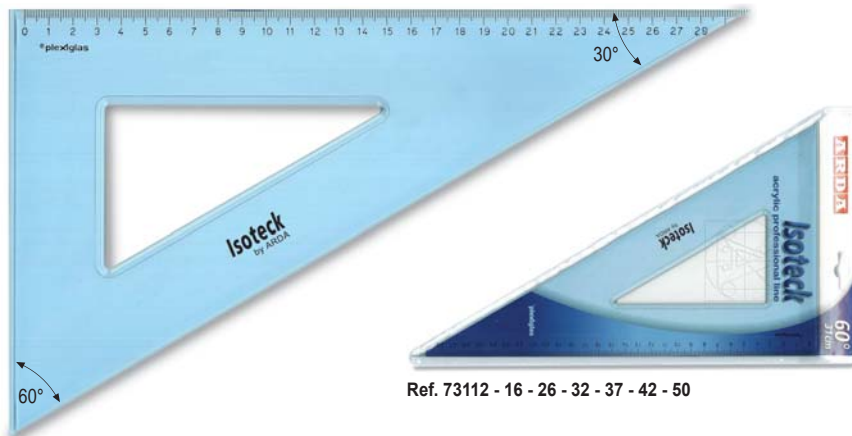

Ref. 73112 - 16 - 26 - 32 - 37 - 42 - 50

Art.	EAN13 art.	Descrizione / Description	INNER pcs	EAN13 inner	MASTER pcs
73112	8003438731128	60° cm. 12	10	8003438733122	10
73116	8003438731166	60° cm. 16	10	8003438733160	10
73126	8003438731265	60° cm. 26	10	8003438733269	10
73132	8003438731326	60° cm. 31	10	8003438733320	10
73137	8003438731371	60° cm. 36	10	8003438733375	10
* 73142	8003438731425	60° cm. 42	1	8003438731425	10
* 73150	8003438731500	60° cm. 50	1	8003438731500	10

Righe

Rulers - Règles



Smusso e tirachina
Bevelled edge and ink-edge
Facette et bord anti-tache

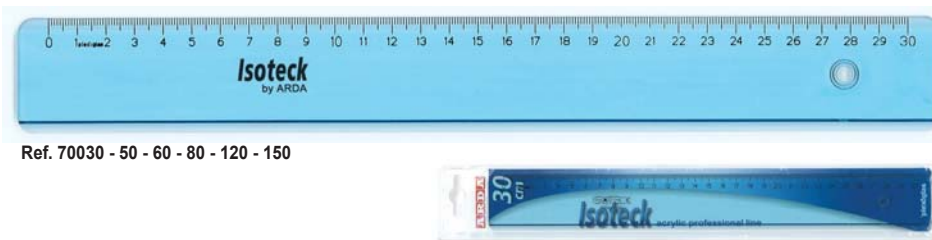

Ref. 70030 - 50 - 60 - 80 - 120 - 150

Art.	EAN13 art.	Descrizione / Description	INNER pcs	EAN13 inner	MASTER pcs
70030	8003438700308	cm. 30	10	8003438710307	10
70050	8003438700506	cm. 50	10	8003438710505	10
70060	8003438700605	cm. 60	10	8003438710604	10
70080	8003438700803	cm. 80	10	8003438710802	10
* 700120	8003438700124	cm. 120	1	8003438700124	5
* 700150	8003438700155	cm. 150	1	8003438700155	5

* Ricavate da lastra - Cut from plate
Découpé à partir de la plaque

Righe per parallelografi

Parallel rulers
Règles pour parallèles



Smusso e tirachina
Bevelled edge and ink-edge
Facette et bord anti-tache

Ref. 70150 - 60 - 70 - 80 -100 -120

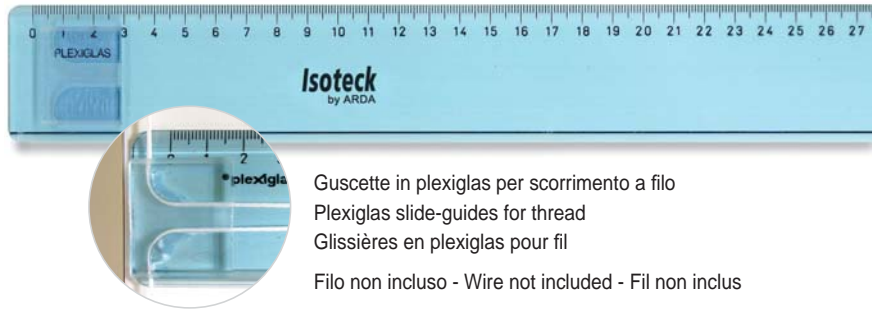

Guscette in plexiglas per scorrimento a filo
Plexiglas slide-guides for thread
Glissières en plexiglas pour fil
Filo non incluso - Wire not included - Fil non inclus

Art.	EAN13 art.	Descrizione / Description	INNER pcs	EAN13 inner	MASTER pcs
70150	8003438701503	cm. 50	1	8003438701503	10
70160	8003438701602	cm. 60	1	8003438701602	10
70170	8003438701701	cm. 70	1	8003438701701	10
70180	8003438701800	cm. 80	1	8003438701800	10
701120	8003438701121	cm. 120	1	8003438701121	10

* Ricavate da lastra - Cut from plate
Découpé à partir de la plaque *

Doppio e Triplo decimetro

Finger grip ruler 20-30cm
Double e triple décimètre

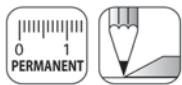

2 millimetrature. Impugnatura lunga.
2 graduations. Long grip.
2 graduations. Longue poignée.



Ref. 68020



Ref. 68030

Art.	EAN13 art.	Descrizione / Description	INNER pcs	EAN13 inner	MASTER pcs
68020	8003438680204	cm. 20	10	8003438681201	10
68030	8003438680303	cm. 30	10	8003438681300	10

Goniometri

Protractor - Rapporteur

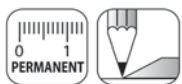

Smusso e bordo interno
Bevelled edge and finger lift
Facette et bord intérieur



Ref. 750

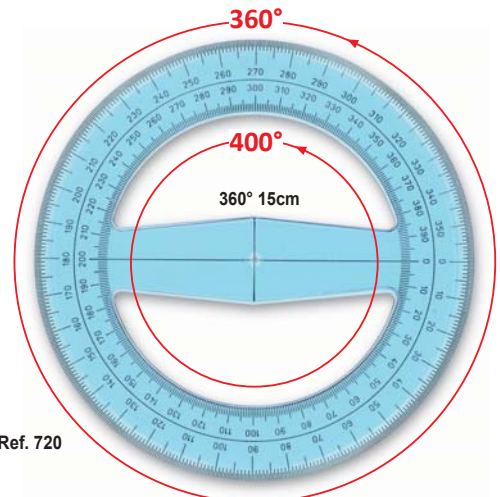

Ref. 720



Art.	EAN13 art.	Descrizione / Description	INNER pcs	EAN13 inner	MASTER pcs
750	8003438007506	180° cm. 15	10	8003438107503	10
720	8003438007209	360° cm. 15	10	8003438107206	10

Espositore da banco in cartone
 Carton desktop display - Presentoir de comptoir en carton

47
 pcs

DISPLAY 47 pz / pcs

Art.	EAN13 art.	Descrizione / Description	INNER	MASTER
641	8003438013620	5x Sq. 45° cm. 31 - ref. 73032 5x Sq. 60° cm. 31 - ref. 73132 5x Sq. 45° cm. 36 - ref. 73037 5x Sq. 60° cm. 36 - ref. 73137 5x Righe cm. 50 - ref. 70050 5x Righe cm. 60 - ref. 70060 10x Triplo dec. cm. 30 - ref. 68030 5x Gon. 180° cm. 15 - ref. 750 1x bar. 15 pz. R15 cm alu - ref.17915BAR 1x bar. 12 portamine 2 mm ref. 4017	1	1

Disponibilità limitata alle campagne promozionali - Product availability limited to promotional campaigns - Disponibilité limitée aux campagnes promotionnelles



Contenuto specifico per disegno tecnico su fogli A3
 Specific content for technical drawing on A3 sheets
 Contenu spécifique pour le dessin technique sur papier A3

Ref. 641
 32,5 x 25 x 65 h. cm

Righe T
 T-squares - Règle à "T"

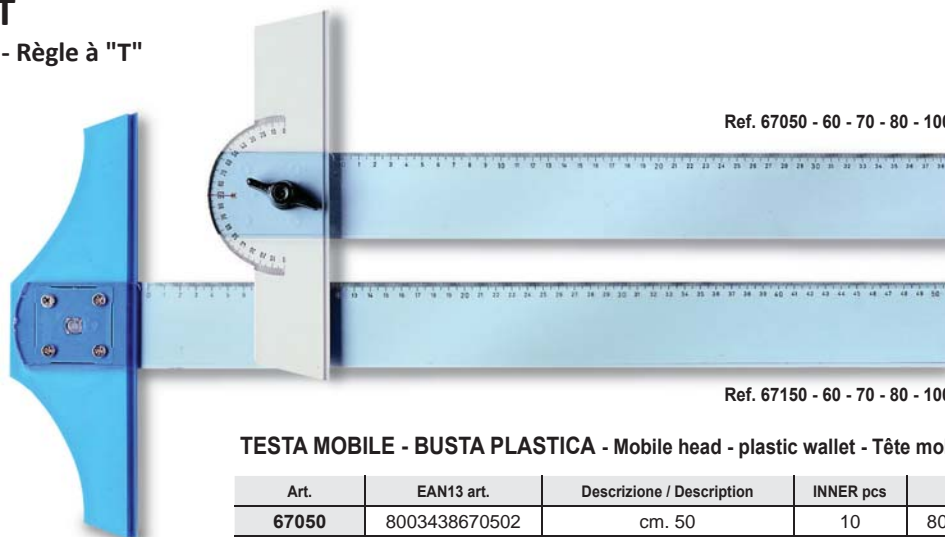

Ref. 67050 - 60 - 70 - 80 - 100

Ref. 67150 - 60 - 70 - 80 - 100

TESTA MOBILE - BUSTA PLASTICA - Mobile head - plastic wallet - Tête mobile - en pochette plastique

Art.	EAN13 art.	Descrizione / Description	INNER pcs	EAN13 inner	MASTER pcs
67050	8003438670502	cm. 50	10	8003438671509	10
67060	8003438670601	cm. 60	10	8003438671608	10
67070	8003438670700	cm. 70	10	8003438671707	10
67080	8003438670809	cm. 80	10	8003438671806	10
* 670100	8003438670106	cm. 100	1	8003438670106	1

TESTA FISSA - BUSTA CELLOPHANE - Fixed head - cellophane wallet - Tête fixe en pochette cellophane

Art.	EAN13 art.	Descrizione / Description	INNER pcs	EAN13 inner	MASTER pcs
67150	8003438671516	cm. 50	10	8003438067159	10
67160	8003438671615	cm. 60	10	8003438067166	10
67170	8003438671714	cm. 70	10	8003438067173	10
67180	8003438671813	cm. 80	10	8003438067180	10
* 671100	8003438711007	cm. 100	1	8003438711007	1

* Ricavate da lastra.
 Riga colore cristallo.

Cut from plate.
 Crystal color ruler.

Découpé à partir de la plaque.
 Règle de couleur cristal.

Scalimetri in plastica

Triangular scale in plastic
Echelle rd réduction en plastique

Sezione triangolare con canaline colorate
Triangular section with coloured grooves
Section triangulaire avec rainures en couleurs divers



Ref. 109 **A** Uso edilizia - For building purposes - Pour construction
1:100 - 200 - 250 - 300 - 400 - 500



Ref. 110 **B** Uso arredamento - For furnishing purposes - Pour ameublement
1:20 - 25 - 50 - 75 - 100 - 125



Ref. 111 **C** Uso catasto - For land registry purposes - Pour Cadastral
1:500 - 1000 - 1250 - 1500 - 2000 - 2500

	Art.	EAN13 art.	Descrizione / Description	INNER pcs	EAN13 inner	MASTER pcs
A	109	8003438001092	EDILIZIA cm.30	1	8003438001092	12
B	110	8003438001108	ARREDAMENTO cm.30	1	8003438001108	12
C	111	8003438001115	CATASTO cm. 30	1	8003438001115	12



Righe speciali 35 cm

Specific rulers 35 cm
Règles spéciales 35 cm

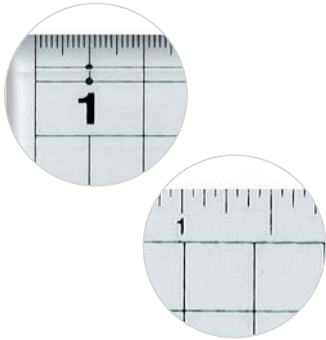

Ref. 97035

Art.	EAN13 art.	Descrizione / Description	INNER pcs	EAN13 inner	MASTER pcs
97035	8003438970350	cm. 5 x 35	10	8003438971357	10

Curvilinee deformabili millimtrate

Flexible curves with graduation
Courbe flexibles avec graduation



Tirachina
Ink-edge
Anti-tache

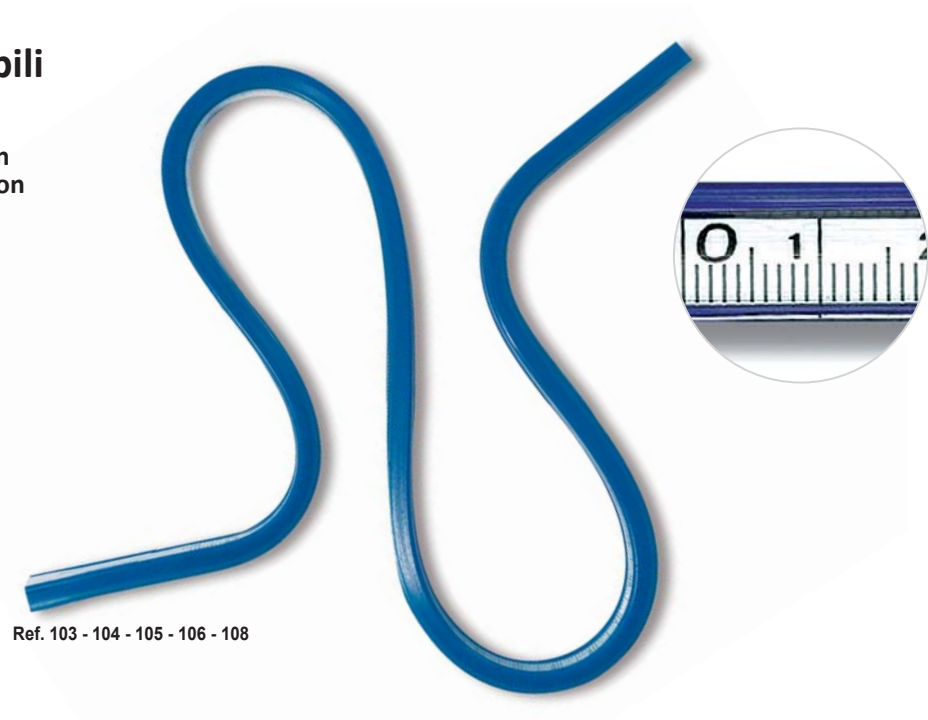

Ref. 103 - 104 - 105 - 106 - 108

Art.	EAN13 art.	Descrizione / Description	INNER pcs	EAN13 inner	MASTER pcs
103	8003438001030	cm. 30	10	8003438101037	10
104	8003438001047	cm. 40	10	8003438101044	10
105	8003438001054	cm. 50	10	8003438101051	10
106	8003438001061	cm. 60	10	8003438101068	10
108	8003438001085	cm. 90	10	8003438101082	10

ALLUMINIO ANODIZZATO CLASSICO E COLORATO



Gli articoli di alluminio sono nati come strumenti professionali e si sono poi largamente diffusi come prodotti scolastici grazie alla robustezza e solidità dell'alluminio.

ANODIZED ALUMINUM CLASSIC AND COLORFUL

The articles of aluminium were conceived as professional tools and have been widely used as educational products thanks to the strength and stability of aluminium.

ALUMINIUM ANODISÉ CLASSIQUE ET COLORÉ

Les articles en aluminium sont nés comme un outil professionnel et ont été largement utilisés comme produits éducatifs grâce à la robustesse et la solidité de l'aluminium.

MADE IN ITALY

ITALIAN QUALITY & STYLE

Squadre 45°

Set square 45° - Equerre 45°

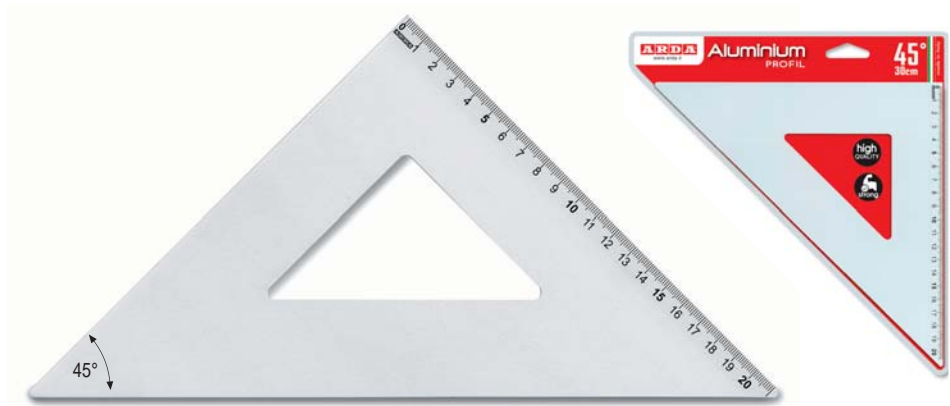

Ref. 18026 - 32 - 40

Art.	EAN13 art.	Descrizione / Description	INNER pcs	EAN13 inner	MASTER pcs
18026	8003438180261	45° cm.25	3	8003438188267	30
18032	8003438180322	45° cm. 30	3	8003438188328	30
18040	8003438180407	45° cm. 35	3	8003438188403	3

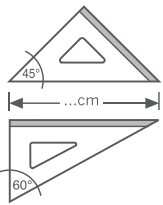

Squadre 60°

Set square 60° - Equerre 60°

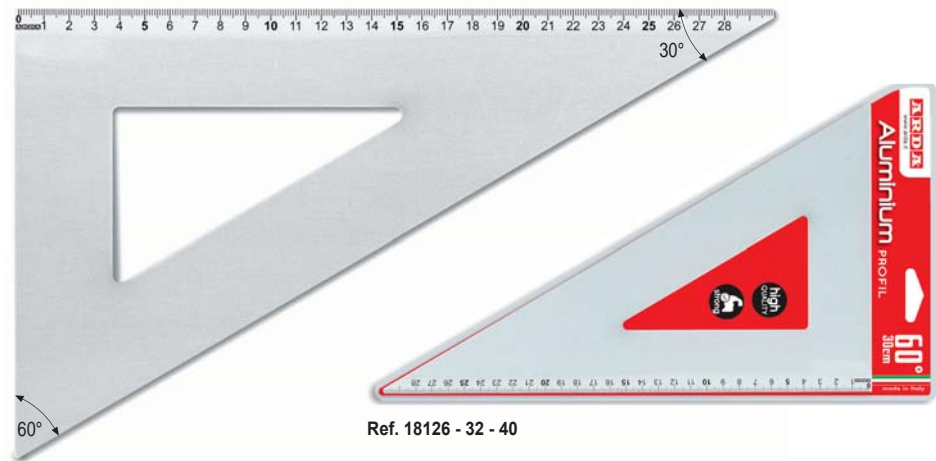
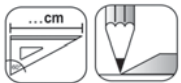

Ref. 18126 - 32 - 40

Art.	EAN13 art.	Descrizione / Description	INNER pcs	EAN13 inner	MASTER pcs
18126	8003438181268	60° cm. 25	3	8003438189264	30
18132	8003438181329	60° cm. 30	3	8003438189325	30
18140	8003438181404	60° cm. 35	3	8003438189400	3

PUNTE ARROTONDATE DI SICUREZZA - ROUND EDGES FOR SECURITY - BOUTS ROUNDS POUR PLUS DE SECURITÉ

Doppio e Triplo decimetro

Finger grip ruler 20-30cm
Double e triple décimètre



Ref. 18420

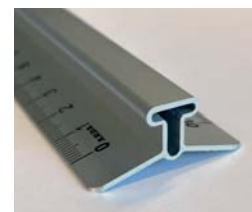

Ref. 18430

2 millimetrature. Impugnatura lunga.
2 graduations. Long grip.
2 graduations. Longue poignée.

Art.	EAN13 art.	Descrizione / Description	INNER pcs	EAN13 inner	MASTER pcs
18420	8003438184207	cm. 20	3	8003438199201	30
18430	8003438184306	cm. 30	3	8003438189301	30

Righe

Rulers - Règles



Gomma antiscivolo e tirachina
With no-sliding rubber and ink-edge
Avec patin antidérapant et bord anti-tache

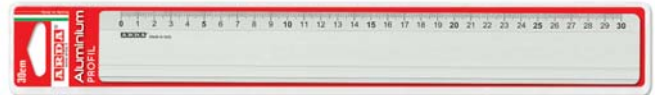

Ref. 18230 - 40 - 50 - 60 - 70 - 80 - 100



LASERTEK
INCISIONE LASER

Art.	EAN13 art.	Descrizione / Description	INNER pcs	EAN13 inner	MASTER pcs
18230	8003438182302	cm. 30	3	8003438198303	30
18240	8003438182401	cm. 40	3	8003438198402	30
18250	8003438182500	cm. 50	3	8003438198501	30
18260	8003438182609	cm. 60	3	8003438198600	30
18270	8003438182708	cm. 70	1	8003438182708	3
18280	8003438182807	cm. 80	1	8003438182807	3
182100	8003438182104	cm. 100	1	8003438182104	3

L'INCISIONE LASER GARANTISCE L'ASSOLUTA INDELEBILITÀ DEI NUMERI E DEI MILLIMETRI
LASER ENGRAVING GUARANTEES THE ABSOLUTE INDELEBILITY OF NUMBERS AND MILLIMETERS
LA GRAVURE AU LASER GARANTIT L'INDELÉBILITÉ ABSOLUE DES NOMBRES ET DES MILLIMÈTRES

Righe bordo acciaio

Rulers. Stainless steel edge - Règles. Bord en acier

Gomma antiscivolo e tirachina
With no-sliding rubber and ink-edge
Avec patin antidérapant et bord anti-tache

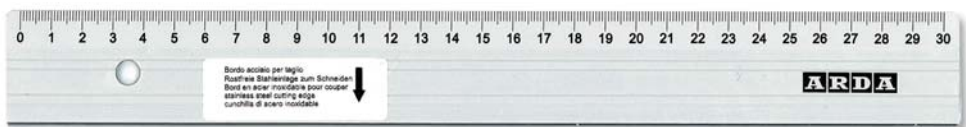
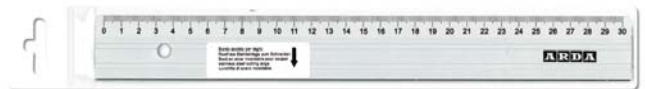

Ref. 18330 - 40 - 50 - 60 - 70 - 80 - 100 - 150



**PROFILO DI ACCIAIO
INOSSIDABILE INTEGRATO PER
RESISTERE AI LAVORI DI TAGLIO**
**INTEGRATED STAINLESS STEEL
PROFILE TO RESIST CUTTING JOBS**
**PROFIL EN ACIER INOXYDABLE
INTÉGRÉ POUR RÉSISTER AUX
TRAVAUX DE COUPE**

Art.	EAN13 art.	Descrizione / Description	INNER pcs	EAN13 inner	MASTER pcs
18330	8003438183309	cm.30	1	8003438183309	10
18340	8003438183408	cm.40	1	8003438183408	10
18350	8003438183507	cm.50	1	8003438183507	10
18360	8003438183606	cm.60	1	8003438183606	10
18370	8003438183705	cm.70	1	8003438183705	10
18380	8003438183804	cm.80	1	8003438183804	5
183100	8003438183101	cm.100	1	8003438183101	5
183150	8003438183156	cm.150	1	8003438183156	5

Goniometro 360°

Protractor 360° - Rapporteur 360°



Millimetrati
With graduation - Avec graduation



Ref. 18715



Art.	EAN13 art.	Descrizione / Description	INNER pcs	EAN13 inner	MASTER pcs
18715	8003438187154	360° cm. 15	1	8003438187154	10

Espositore da banco in cartone

Carton desktop display - Presentoir de comptoir en carton



26
pcs

DISPLAY 26 pz / pcs

Art.	EAN13 art.	Descrizione / Description	INNER	MASTER
180ESP	8003438017215	3x Sq. 45° cm. 30 - ref. 18032	1	1
		3x Sq. 60° cm. 30 - ref. 18132		
		1x Barattolo righelli 10cm ref. 17910BAR		
		1x Barattolo righelli 15cm ref. 17915BAR		
		6x Righe cm. 50 - ref. 18250		
		6x Doppio dec. cm. 20 - ref. 18420 6x Triplo dec. cm. 30 - ref. 18430		

Disponibilità limitata alle campagne promozionali - Product availability limited to promotional campaigns - Disponibilité limitée aux campagnes promotionnelles



Contenuto specifico per disegno tecnico su fogli A3
Specific content for technical drawing on A3 sheets
Contenu spécifique pour le dessin technique sur papier A3

Ref. 180ESP
Display 32,5 x 25 x 57 h. cm

Righe T

T-squares - Règle à "T"

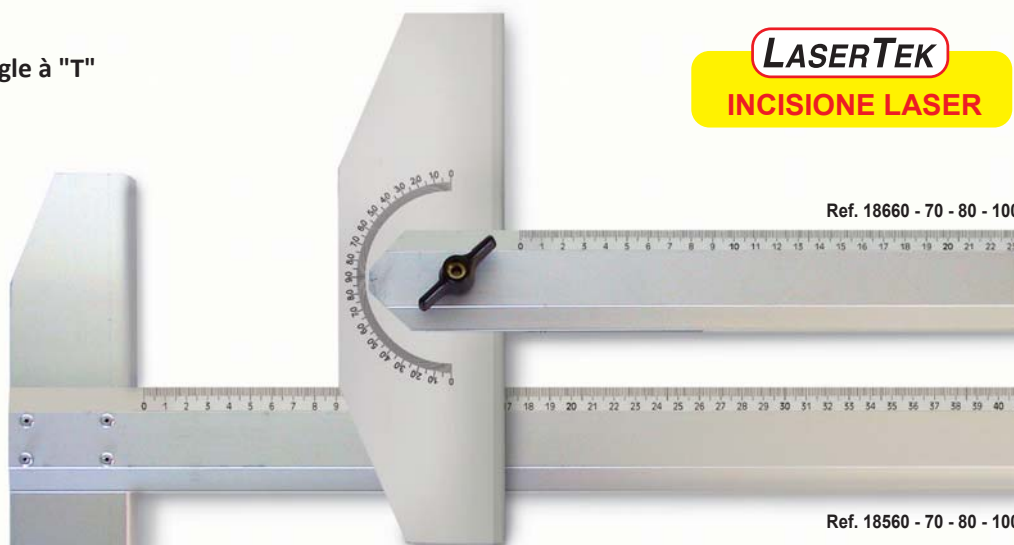

Ref. 18660 - 70 - 80 - 100

Ref. 18560 - 70 - 80 - 100

TESTA FISSA - Fixed head - Tête fixe

Art.	EAN13 art.	Descrizione / Description	INNER pcs	EAN13 inner	MASTER pcs
18560	8003438185600	cm.60	1	8003438185600	5
18570	8003438185709	cm.70	1	8003438185709	5
18580	8003438185808	cm.80	1	8003438185808	5
185100	8003438185105	cm.100	1	8003438185105	1

L'INCISIONE LASER GARANTISCE L'ASSOLUTA INDELEBILITÀ DEI NUMERI E DEI MILLIMETRI

LASER ENGRAVING GUARANTEES THE ABSOLUTE INDELEBILITY OF NUMBERS AND MILLIMETERS

LA GRAVURE AU LASER GARANTIT L'INDELÉBILITÉ ABSOLUE DES NOMBRES ET DES MILLIMÈTRES

TESTA MOBILE - Mobile head - Tête mobile

Art.	EAN13 art.	Descrizione / Description	INNER pcs	EAN13 inner	MASTER pcs
18660	8003438186607	cm.60	1	8003438186607	5
18670	8003438186706	cm.70	1	8003438186706	5
18680	8003438186805	cm.80	1	8003438186805	5
186100	8003438186102	cm.100	1	8003438186102	1

Barattoli 15 righelli

Pot containing 15 rulers
Pot de 15 règle

Bordo tirachina
Ink-edge - Bord anti-tache

cm 10 - cm 15 - cm 20



Ref. 17910BAR
15 pz

Ref. 17915BAR
15 pz

Ref. 17920BAR
15 pz

Art.	EAN13 art.	Descrizione / Description	INNER pcs	EAN13 inner	MASTER pcs
17910BAR	8003438007438	Bar.15 pz - cm.10 (ean pz 8003438 015471)	1	8003438007438	12
17915BAR	8003438006981	Bar.15 pz - cm.15 (ean pz 8003438 015457)	1	8003438006981	10
17920BAR	8003438023414	Bar.15 pz - cm.20 (ean pz 8003438 023407)	1	8003438023414	10

Righelli in busta singola

Rulers individual bag
Règles pochette individuelle

Bordo tirachina
Ink-edge - Bord anti-tache



Ref. 17920SS - cm.20

Art.	EAN13 art.	Descrizione / Description	INNER pcs	EAN13 inner	MASTER pcs
17910SS	8003438019141	cm 10 - busta SS	10	8003438019202	10
17915SS	8003438007032	cm 15 - busta SS	10	8003438007230	10
17920SS	8003438007049	cm 20 - busta SS	10	8003438007063	10

Squadrette cm. 12 e minikit 3 pz.

Small set square cm. 12 and minikit 3 pcs.
Petites équerres cm. 12 et minikit 3 pcs

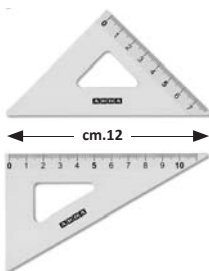

Ref. 18012
45° cm.12



Ref. 18112
60° cm.12



Ref. 80312
45° cm.12 + 60° cm.12



Ref. 1893 - Miniset 3 pz/pcs :
45° 12 cm + 60° 12 cm + Riga 15 cm

Art.	EAN13 art.	Descrizione / Description	INNER pcs	EAN13 inner	MASTER pcs
18012	8003438025685	45° cm.12	10	8003438025708	10
18112	8003438025692	60° cm.12	10	8003438025715	10
80312	8003438007414	45° + 60° cm.12	10	8003438007421	10
1893	8003438022752	miniset 3 pz/pcs	10	8003438022769	10

Espositore

Display - Presentoir

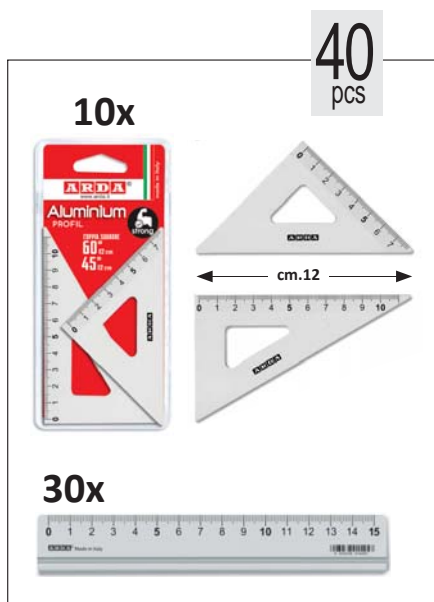

Ref. 182ESP
11,5 x 18,4 x 27,3 h. cm

Art.	EAN13 art.	Descrizione / Description	INNER	EAN13 inner	MASTER
182ESP	8003438031679	Display 40 pz : 30 righelli cm.15 (ean pz 8003438 015457) + 10 coppie squadre cm.12 (ref. 80312)	1	8003438031679	1

Barattoli righelli e display FROST

Pot containing rulers and display
Pot de règle et presentoir

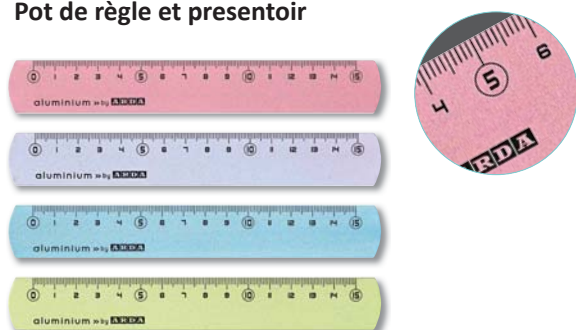

Ref. 17815COLBAR
24 pz/pcs



Ref. 17820COLBAR
24 pz/pcs



Ref. 178SQ
40 pz/pcs

Art.	EAN13 art.	Descrizione / Description	INNER	EAN13 inner	MASTER
17815COLBAR	8003438022127	Barattolo 24 righelli alu cm. 15 - col. ass. (ean pz 8003438022189)	1	8003438022127	10
17820COLBAR	8003438022134	Barattolo 24 righelli alu cm. 20 - col. ass. (ean pz 8003438022196)	1	8003438022134	10
178SQ	8003438027894	Display 40 pz: 20x 45°cm.12 (ean pz 8003438023285) + 20x 60°cm.12 (ean pz 8003438023292)	1	8003438027894	1

RE-GENERATION

PER UNO SVILUPPO SOSTENIBILE
FOR A SUSTAINABLE DEVELOPMENT

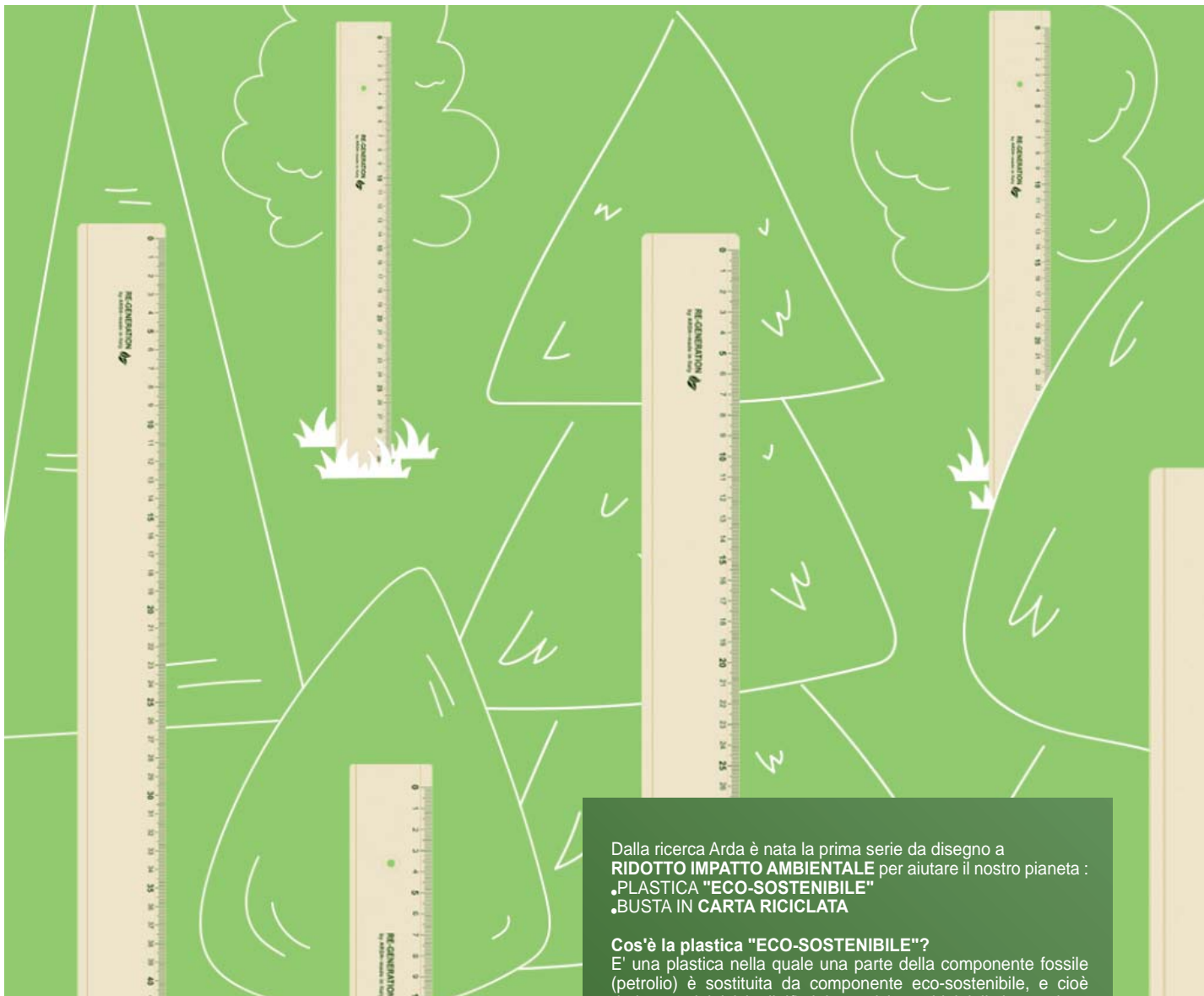

Thanks to ARDA's commitment to environmental issues and deep research, the first drawing line with **REDUCED ENVIRONMENTAL IMPACT** was created to reduce harm to the planet :

- **ECO-SUSTAINABLE** plastic
- **RECYCLED PAPER** bag

What is **ECO-SUSTAINABLE PLASTIC**?

That is a type of plastic in which a part of the fossil component (oil) is replaced by an eco-sustainable component deriving from the recycling of household waste and woodworking residues.

Benefits of **eco SUSTAINABLE PLASTIC**

- **100% RECYCLABLE**
- Allows reuse of household waste
- Reduces the use of the fossil component (oil)
- Reduces greenhouse gas emissions by up to 74%
- Preserves agricultural resources because it doesn't involve extensive land exploitation.

L'équipe de recherche d'ARDA a donné naissance à la première gamme de traçage à **IMPACT ENVIRONNEMENTAL RÉDUIT** pour sauvegarder le planète.

- Plastique **ÉCO-RESPONSABLE**
- Emballage en **PAPIER RECYCLÉ**

QU'EST-CE QUE DU **PLASTIQUE ÉCO-RESPONSABLE** ?

C'est une matière plastique dans laquelle une partie des composés fossiles (issus du pétrole) est substitué par des composés durables issus du recyclage des déchets ménagers et des résidus de la transformation du bois.

Dalla ricerca Arda è nata la prima serie da disegno a **RIDOTTO IMPATTO AMBIENTALE** per aiutare il nostro pianeta :
• **PLASTICA "ECO-SOSTENIBILE"**
• **BUSTA IN CARTA RICICLATA**

Cos'è la plastica "**ECO-SOSTENIBILE**"?

E' una plastica nella quale una parte della componente fossile (petrolio) è sostituita da componente eco-sostenibile, e cioè derivante dal riciclo di rifiuti domestici e residui della lavorazione del legno.

Vantaggi della plastica "**ECO-SOSTENIBILE**"

- **RICICLABILE AL 100%**
- permette il riutilizzo di rifiuti domestici
- riduce l'utilizzo di materiale di origine fossile (petrolio).
- riduce l'emissione gas serra fino al 74%
- preserva le risorse dell'agricoltura poiché non implica lo sfruttamento intensivo dei terreni.

Made in Italy

LES AVANTAGES DU **PLASTIQUE ÉCO-RESPONSABLE**

- **RECYCLABLE À 100%**
- Permet la valorisation des déchets domestiques
- Réduit l'utilisation des matériaux fossiles
- Réduction émission de gaz à effet de serre jusqu'à 74%
- Préserve les ressources agricoles puisqu'il n'implique pas l'exploitation intensive des terres cultivables.

Squadre 45° e 60°
Set square 45° and 60°
Equerre 45° et 60°

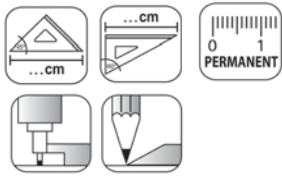

Smusso, tirachina e bordo interno
Bevelled edge, ink-edge and finger lift
Facette, bord anti-tache et bord intérieur

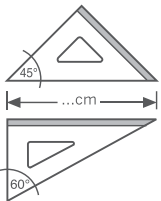

Ref. RE4530

Art.	EAN13 art.	Descrizione / Description	INNER pcs	EAN13 inner	MASTER pcs
RE4530	8003438028020	45° cm. 30	10	8003438028099	10

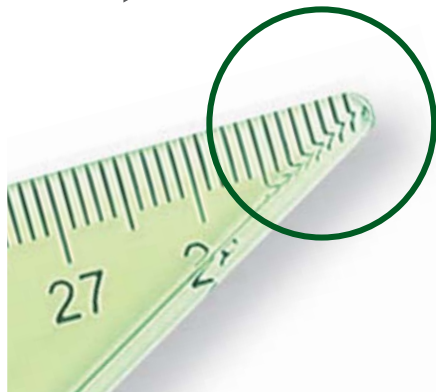

PUNTE ARROTONDATE DI SICUREZZA

ROUND EDGES FOR SECURITY

BOUTS RONDS POUR PLUS DE SECURITÉ

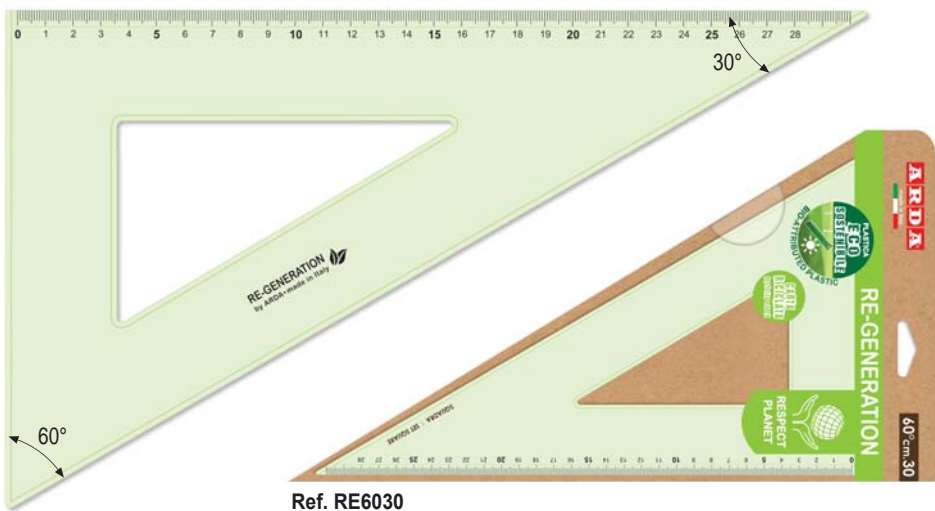

Ref. RE6030

Art.	EAN13 art.	Descrizione / Description	INNER pcs	EAN13 inner	MASTER pcs
RE6030	8003438028037	60° cm. 30	10	8003438028105	10

Righe

Rulers - Règles



Smusso e tirachina
Bevelled edge and ink-edge
Facette et bord anti-tache



Ref. RE30 - 50

Art.	EAN13 art.	Descrizione / Description	INNER pcs	EAN13 inner	MASTER pcs
RE30	8003438028044	cm. 30	10	8003438028112	10
RE50	8003438028051	cm. 50	10	8003438028129	10

Goniometro 360°

Protractor 360°
Rapporteur 360°



Smusso e bordo interno
Bevelled edge and finger lift
Facette et bord intérieur

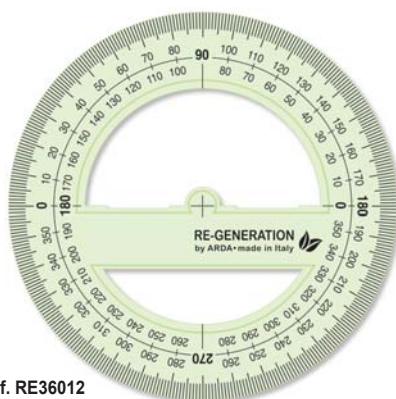

Ref. RE36012

Art.	EAN13 art.	Descrizione	INNER pcs	EAN13 inner	MASTER pcs
RE36012	8003438028068	360°cm.12	10	8003438028136	10

Squadra geometrica

Geometric square
Equerre géométrique



4 FUNZIONI IN 1
4 FUNCTIONS IN 1
4 USAGES EN 1

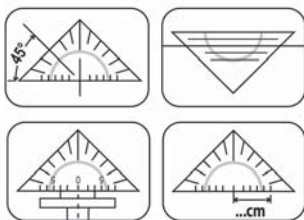

Ref. REGEO300

Art.	EAN13 art.	Descrizione / Description	INNER pcs	EAN13 inner	MASTER pcs
REGEO300	8003438028075	45°cm.16	10	8003438028143	200

Barattolo 24 righelli

Pot 24 rulers
Pot de 24 règles
cm.16



Ref. RE15BAR

Art.	EAN13 art.	Descrizione / Description	INNER pcs	EAN13 inner	MASTER pcs
RE15BAR	8003438028327	cm.16	1	8003438028327	10

Articolo singolo / Each articles / Article à l'unité : 8003438028310

Espositore da banco in cartone
 Carton desktop display Presentoir de comptoir en carton

51 pz / pcs

Art.	EAN13 art.	Descrizione / Description	INNER	MASTER
RE4768	8003438028167	10x Sq. 45°cm.30 - ref.RE4530 10x Sq. 60°cm.30 - ref. RE6030 10x Righie cm. 30 - ref. RE30 10x Righie cm. 50 - ref. RE50 10x Gon. 360°cm.12 - ref.RE36012 1x bar.24 righelli cm.16 - ref.RE15BAR	1	1

Disponibilità limitata alle campagne promozionali - Product availability limited to promotional campaigns - Disponibilité limitée aux campagnes promotionnelles



Ref. RE4768
 32,5 x 25 x 60 h. cm



Contenuto specifico per disegno tecnico su fogli A3
 Specific content for technical drawing on A3 sheets
 Contenu spécifique pour le dessin technique sur papier A3



**WE RESPECT
 OUR PLANET**

**DISPLAY IN CARTONE RICICLATO
 DISPLAY MADE OF RECYCLED CARTON**

Espositore da terra in cartone
 Carton floor display - Presentoir au sol en carton

200 pz / pcs

Art.	EAN13 art.	Descrizione / Description	INNER	MASTER
500RE	8003438 028471	40x Sq. 45°cm.30 - ref.RE4530 40x Sq. 60°cm.30 - ref. RE6030 40x Righie cm. 30 - ref. RE30 40x Righie cm. 50 - ref. RE50 40x Gon. 360°cm.12 - ref.RE36012	1	1

Disponibilità limitata alle campagne promozionali - Product availability limited to promotional campaigns - Disponibilité limitée aux campagnes promotionnelles



Ref. 500RE

Espositore da banco in cartone

Carton desktop display Presentoir de comptoir en carton



85
pcs



48x ref. R17REBAR
righelli / rulers / règles cm.16



10x ref. 7063RE
miniset 3 pz/pcs



24x ref. TE800RESC
temperamatite /
sharpeners / taille-crayons



3x ref. CO2RE
set balaustrone / quick-set
compass / set balaustrade

Ref. 1630006
40 x 24 x 30 h. cm

Art.	EAN13 art.	Descrizione / Description	INNER pcs	EAN13 inner	MASTER pcs
1630006	8003438029447	Display 85 pz contenente: - n°48 righelli / rulers / règles cm.16 - ref. R17REBAR - n°10 miniset 3 pz/pcs - ref. 7063RE - n°3 set balaustrone / quick-set compass / set balaustrade - ref. CO2RE - n°24 temperamatite / sharpeners / taille-crayons Clack - ref. TE800RESC	1	8003438029447	1

Miniset disegno in busta con zip

Drawing miniset in bag with zip - Miniset en pochette avec trous

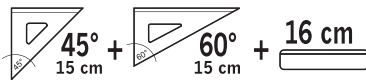

FORATURA UNIVERSALE - MULTI PUNCHES - PERÇAGE UNIVERSEL

Art.	EAN13 art.	Descrizione / Description	INNER pcs	EAN13 inner	MASTER pcs
7063RE	8003438029522	Miniset 3 pz/pcs	10	8003438029539	10

Espositore da terra in cartone
 Carton floor display - Presentoir au sol en carton

188
 pcs

188 pz / pcs

Art.	EAN13 art.	Descrizione / Description	INNER	MASTER
500RE01	8003438 030979	RE-GENERATION 20x Sq. 45°cm.30 - ref. RE4530 20x Sq. 60°cm.30 - ref. RE6030 20x Righe cm. 30 - ref. RE30 20x Righe cm. 50 - ref. RE50 20x Gon. 360°cm.12 - ref. RE36012	1	1
		BLACK is the NEW GREEN 20x Forbice cm.15 - ref. FB15RE 20x Forbice cm.18 - ref. FB18RE 20x Forbice cm.21 - ref. FB21RE 6x Balaustrone kit 6 pz - ref. CO2RE 10x Miniset 3 pz - ref. 7063RE 12 x astucci portapenne - ref. 0231REG		

Disponibilità limitata alle campagne promozionali - Product availability limited to promotional campaigns - Disponibilité limitée aux campagnes promotionnelles



Contenuto specifico per disegno tecnico su fogli A3
 Specific content for technical drawing on A3 sheets
 Contenu spécifique pour le dessin technique sur papier A3



**WE RESPECT
 OUR PLANET**

**DISPLAY IN CARTONE RICICLATO
 DISPLAY MADE OF RECYCLED CARTON**



**DISEGNO
 DRAWING**



PER DISEGNO TECNICO E SCOLASTICO

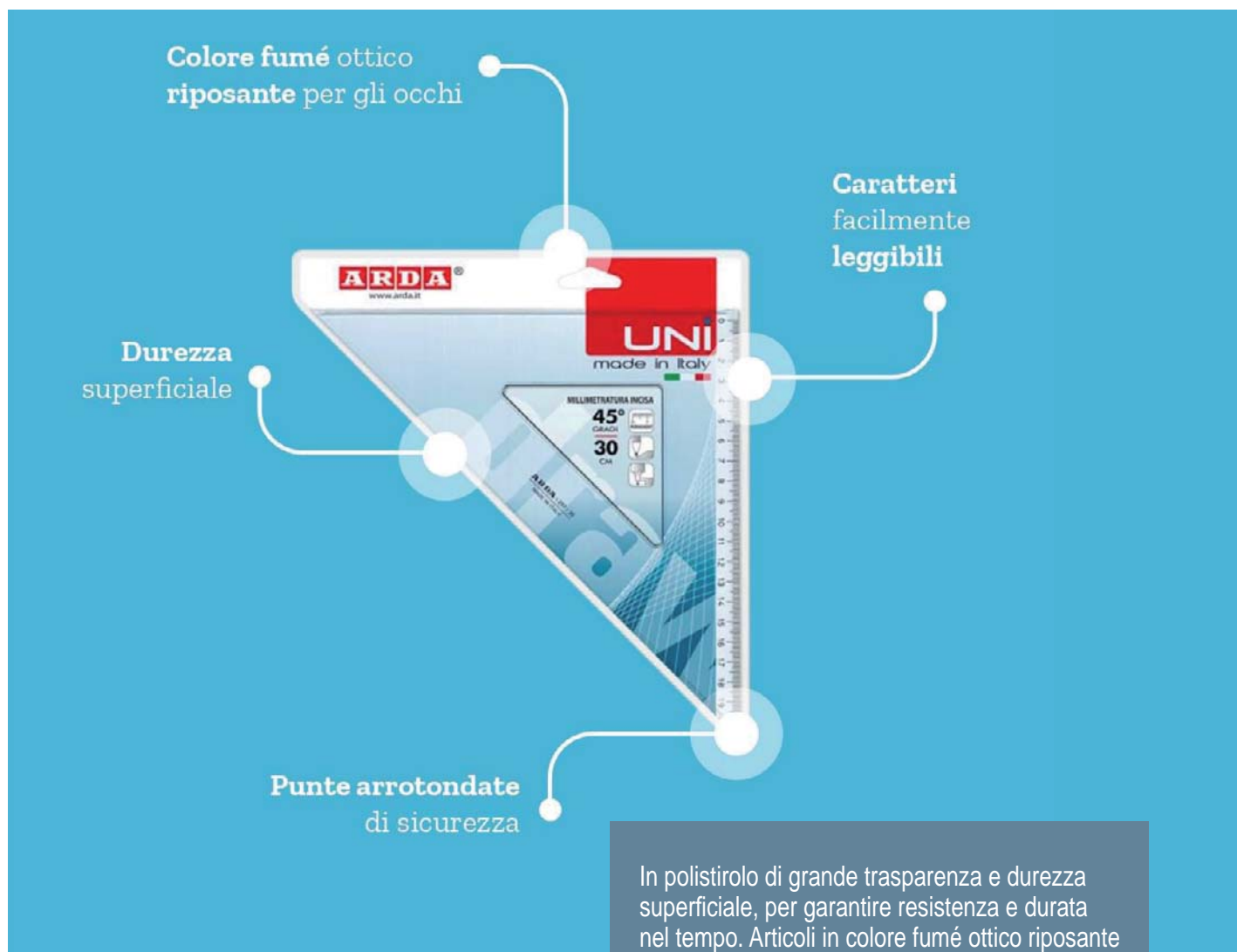

FOR TECHNICAL AND SCHOOL USE

Produced using polystyrene with a high level of transparency and surface hardness to guarantee toughness and long-term durability. The articles are in smoky grey, suitable for all types of use. The graduation is heat etched, easy to read and very accurate. Most of the articles are equipped with an inking edge on the non-graduated sides. The articles are packaged in individual pouches with hang tabs which can be re-used to protect the item from scratching and breakage. Packaging in personalised boxes containing 20 pieces.

POUR EMPLOI TECHNIQUE ET SCOLAIRE.

Elle est réalisée en polystyrène d'une transparence très élevée et dureté superficielle qui garantissent résistance et dureté dans le temps. Les articles sont en couleur gris fumé indiqué pour tous les usages. La graduation est gravée à chaud avec des chiffres très clairement lisibles et précis. La plupart des articles est fournie avec un bord antitache sur les côtés non gradués. Les articles sont conditionnés sous pochette accrochable qu'on peut réutiliser pour protéger le produit de rayures et ruptures. Les boîtes sont de 20 pcs. à la marque propre.

In polistirolo di grande trasparenza e durezza superficiale, per garantire resistenza e durata nel tempo. Articoli in colore fumé ottico riposante per gli occhi. Graduazione incisa a caldo con caratteri facilmente leggibili e molto precisi. La maggior parte degli articoli è munita di bordo tira-china sui lati non graduati. Gli articoli sono confezionati in busta appendibile che può essere riutilizzata per proteggere il prodotto da graffi e rotture. Imballo in scatole da 20 pezzi.

MADE IN ITALY

 ITALIAN QUALITY & STYLE

Squadre 45°

Set square 45° - Equerre 45°

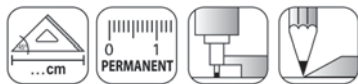

Smusso, tirachina e bordo interno
Bevelled edge, ink-edge and finger lift
Facette, bord anti-tache et bord intérieur

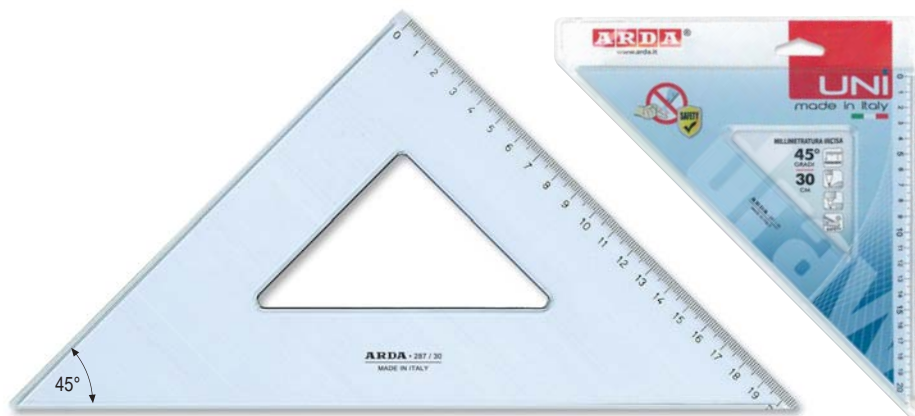

Ref. 28712- 15 - 20 - 25 - 30 - 35 SS

Art.	EAN13 art.	Descrizione / Description	INNER pcs	EAN13 inner	MASTER pcs
28712SS	8003438287120	45° cm. 12	20	8003438487124	500
28715SS	8003438287151	45° cm. 15	20	8003438487155	900
28720SS	8003438287205	45° cm. 20	20	8003438487209	400
28725SS	8003438287250	45° cm. 25	20	8003438487254	300
28730SS	8003438287304	45° cm. 30	20	8003438487308	200
28735SS	8003438287359	45° cm. 35	20	8003438487353	160

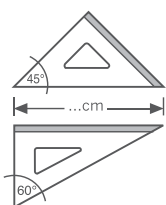

Squadre 60°

Set square 60° - Equerre 60°

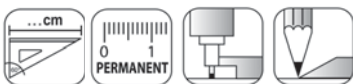

Smusso, tirachina e bordo interno
Bevelled edge, ink-edge and finger lift
Facette, bord anti-tache et bord intérieur

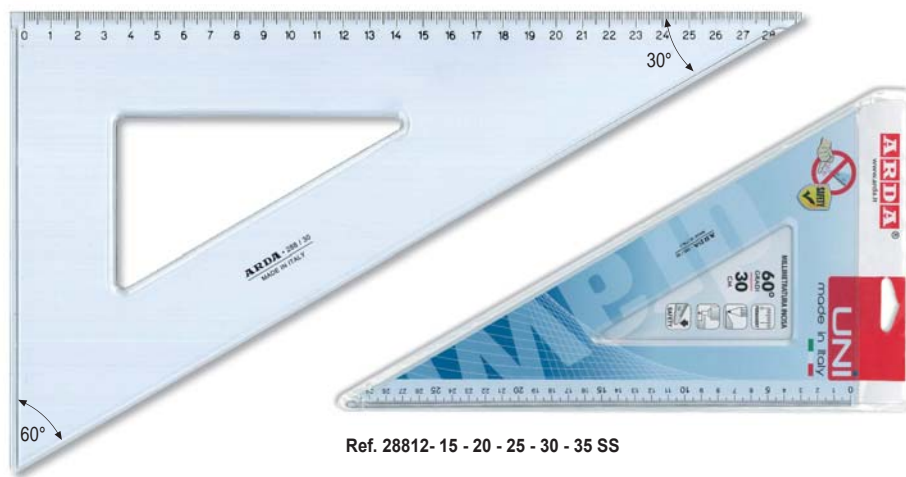

Ref. 28812- 15 - 20 - 25 - 30 - 35 SS

Art.	EAN13 art.	Descrizione / Description	INNER pcs	EAN13 inner	MASTER pcs
28812SS	8003438288127	60° cm. 12	20	8003438488121	500
28815SS	8003438288158	60° cm. 15	20	8003438488152	880
28820SS	8003438288202	60° cm. 20	20	8003438488206	400
28825SS	8003438288257	60° cm. 25	20	8003438488251	260
28830SS	8003438288301	60° cm. 30	20	8003438488305	200
28835SS	8003438288356	60° cm. 35	20	8003438488350	200

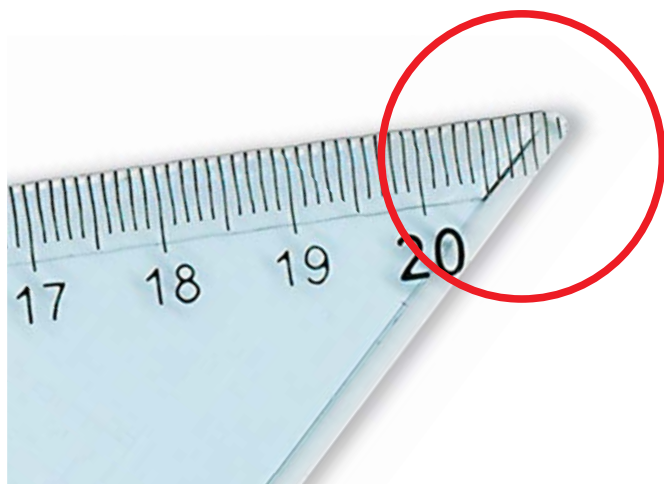

PUNTE ARROTONDATE DI SICUREZZA
ROUND EDGES FOR SECURITY
BOUTS RONDS POUR PLUS DE SECURITÉ

Righe

Rulers - Règles



Smusso e tirachina
Bevelled edge and ink-edge
Facette et bord anti-tache



Ref. 28920 - 30 - 40 - 50 - 60 SS □ Ref. 28970C - 80C - 100C - 120C

Art.	EAN13 art.	Descrizione / Description	INNER pcs	EAN13 inner	MASTER pcs
28917SS	8003438012937	cm. 17	20	8003438012944	800
28920SS	8003438289209	cm. 20	20	8003438489203	700
28930SS	8003438289308	cm. 30	20	8003438489302	400
50030SS	8003438050038	cm. 30 bianco/white/blanc	20	8003438450036	360
28940SS	8003438289407	cm. 40	20	8003438489401	200
28950SS	8003438289506	cm. 50	20	8003438489500	200
28960SS	8003438289605	cm. 60	20	8003438489609	200
* 28970C	8003438289704	cm. 70	10	8003438489708	10
* 28980C	8003438289803	cm. 80	10	8003438489807	10

Cm. 100 e cm. 120 : colore cristallo e materiale flessibile super resistente
cristal color - strong and flexible material / couleur cristal - matière durable et flexible

* 289100C	8003438289100	cm. 100 (colore cristallo)	1	8003438289100	10
* 289120C	8003438026125	cm.120 (colore cristallo)	1	8003438026125	10

* Packaging : busta cellophane

Righe graduazione verticale

Rulers vertical graduation
Règles graduation verticale

Smusso e tirachina
Bevelled edge and ink-edge
Facette et bord anti-tache

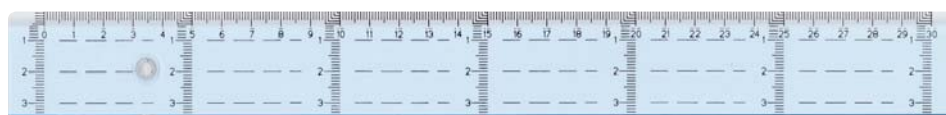
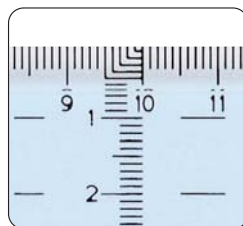

Ref. 28920 - 30 - 40 - 50 GVSS

Art.	EAN13 art.	Descrizione / Description	INNER pcs	EAN13 inner	MASTER pcs
28920GVSS	8003438289216	cm. 20	20	8003438489210	700
28930GVSS	8003438289315	cm. 30	20	8003438489319	400
28940GVSS	8003438289414	cm. 40	20	8003438489418	200
28950GVSS	8003438289513	cm. 50	20	8003438489517	200

Decimetro

Ruler 10cm - Décimètre

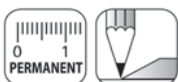

**DOPPIA GRADUAZIONE
DOUBLE GRADUATION
mm / inch**



Ref. 280C

Art.	EAN13 art.	Descrizione / Description	INNER pcs	EAN13 inner	MASTER pcs
280C	8003438002808	Decimetro - 10 cm	20	8003438202802	500

Doppio e triplo decimetro

Finger grip ruler 20 and 30 cm
Double et triple décimètre

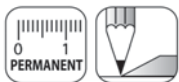

Ref. 283SS impugnatura corta • short grip • poignée courte



Ref. 286SS impugnatura lunga • long grip • poignée longue



Ref. 50130SS impugnatura lunga • long grip • poignée longue

Art.	EAN13 art.	Descrizione / Description	INNER pcs	EAN13 inner	MASTER pcs
283SS	8003438002839	20 cm - impugnatura corta/short grip/poignée courte	20	8003438022837	300
286SS	8003438002860	20 cm - impugnatura lunga/long grip/poignée longue	20	8003438028600	240
50130SS	8003438005014	30 cm - impugnatura lunga/long grip/poignée longue	20	8003438025012	160

Goniometri 180°

Protractor 180° - Rapporteur 180°

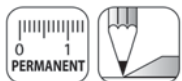

Smusso e bordo interno
Bevelled edge and finger lift
Facette et bord intérieur



Ref. 294SS
Con decimetro - With ruler 10 cm - Avec décimètre

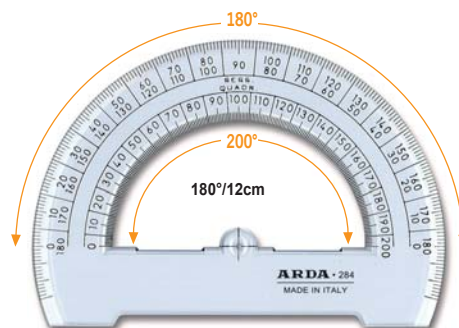

Ref. 284SS

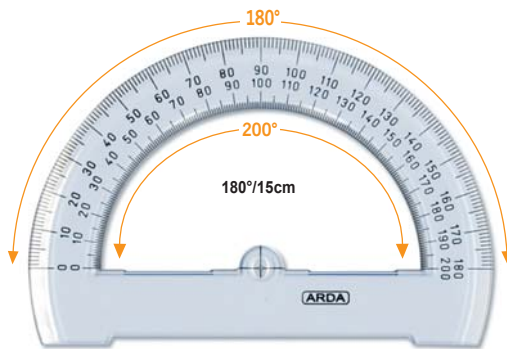

Ref. 296SS



Art.	EAN13 art.	Descrizione / Description	INNER pcs	EAN13 inner	MASTER pcs
294SS	8003438002945	180° cm.10 con decim.	20	8003438212948	900
284SS	8003438002846	180° cm.12	20	8003438212849	660
296SS	8003438002969	180° cm.15	20	8003438202963	20

Goniometri 360°

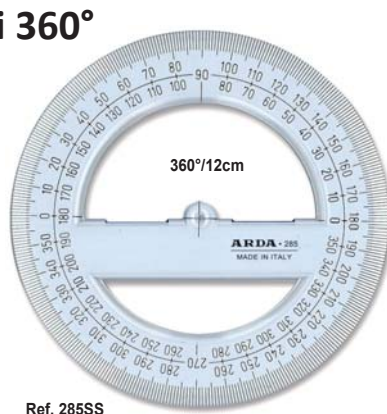
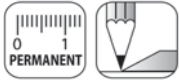
Protractor 360°
Rapporteur 360°

Ref. 285SS

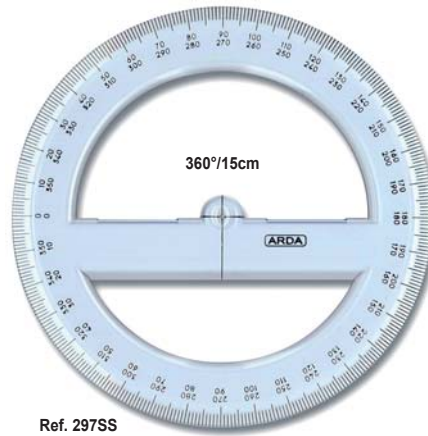

Ref. 297SS

Smusso e bordo interno
Bevelled edge and finger lift
Facette et bord intérieur

Art.	EAN13 art.	Descrizione / Description	INNER pcs	EAN13 inner	MASTER pcs
285SS	8003438002853	360° cm.12	20	8003438212856	480
297SS	8003438002976	360° cm.15	20	8003438202970	360

Curvilinee

French curves
Set de 3 pistoletsCon doppio tirachina
With double ink-edge
Double bord anti-tache

Ref. 29012



Art.	EAN13 art.	Descrizione / Description	INNER pcs	EAN13 inner	MASTER pcs
29012	8003438290120	Set 3 pz. curvilinee/french curves/pistolets	10	8003438229014	190

Espositore da banco in metallo

Desktop metal display
Presentoir de comptoir en metal

DISPLAY 200 pz / pcs

Art.	EAN13 art.	Descrizione / Description	INNER	MASTER
4765	8003438047656	20x Sq. 45° cm. 30 - ref.28730SS 20x Sq. 60° cm. 30 - ref.28830SS 20x Sq. 45° cm. 35 - ref.28735SS 20x Sq. 60° cm. 35 - ref.28835SS 20x Righe cm.50 - ref. 28950SS 20x Righe cm.60 - ref. 28960SS 20x Doppio dec. cm.20 - ref.283SS 20x Triplo dec. cm.30 - ref. 50130SS 20x Gon. 180°cm.12 - ref. 284SS 20x Gon. 360°cm.12 - ref. 285SS	1	1

200
pcs

Disponibilità limitata alle campagne promozionali - Product availability limited to promotional campaigns - Disponibilité limitée aux campagnes promotionnelles

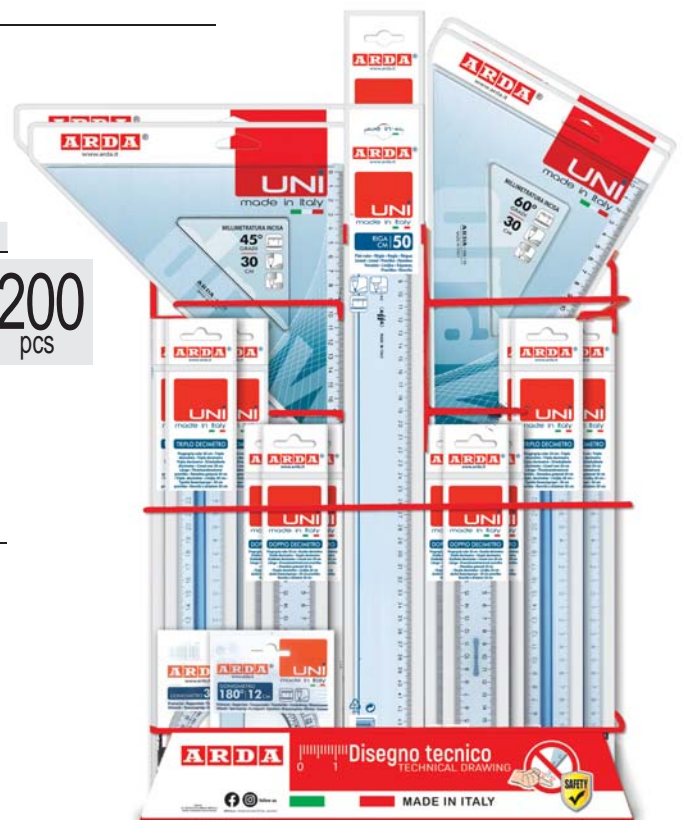
Contenuto specifico per disegno tecnico su fogli A3
Specific content for technical drawing on A3 sheets
Contenu spécifique pour le dessin technique sur papier A3

Ref. 4765

39,5 x 19 x 63 h. cm

Righe T

T-squares - Règle à "T"

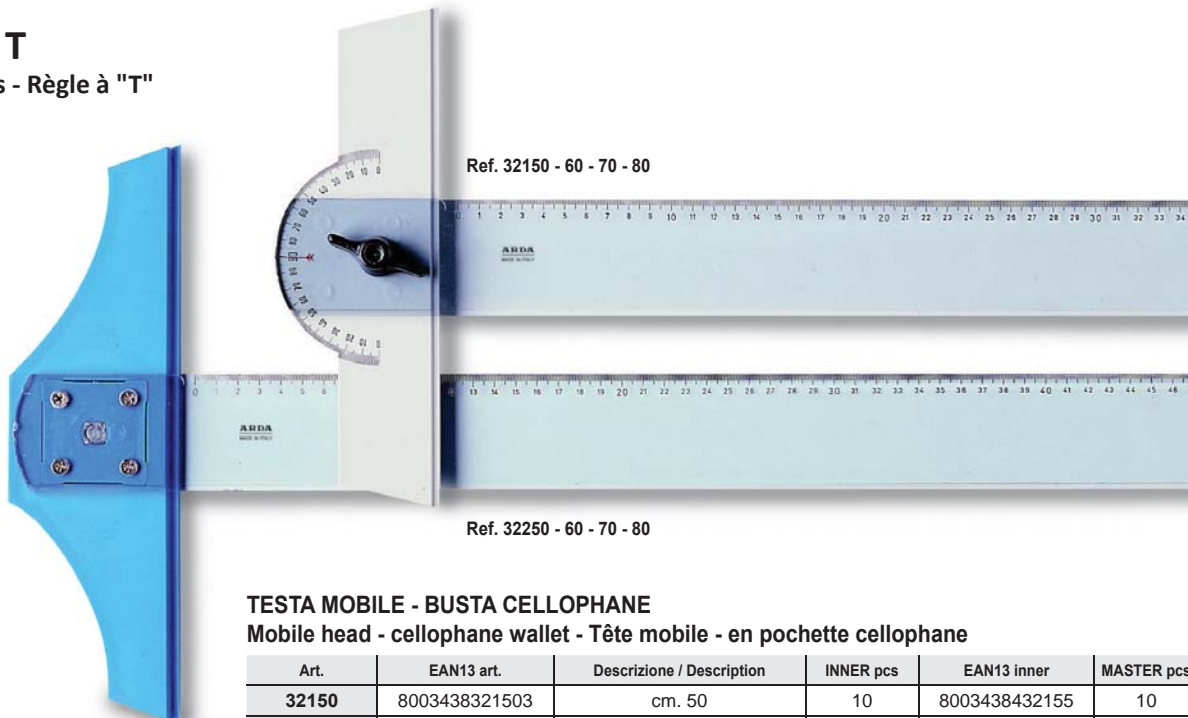

TESTA MOBILE - BUSTA CELLOPHANE

Mobile head - cellophane wallet - Tête mobile - en pochette cellophane

Art.	EAN13 art.	Descrizione / Description	INNER pcs	EAN13 inner	MASTER pcs
32150	8003438321503	cm. 50	10	8003438432155	10
32160	8003438321602	cm. 60	10	8003438432162	10
32170	8003438321701	cm. 70	10	8003438432179	10
32180	8003438321800	cm. 80	10	8003438432186	10

TESTA FISSA - BUSTA CELLOPHANE

Fixed head - cellophane wallet - Tête fixe en pochette cellophane

Art.	EAN13 art.	Descrizione / Description	INNER pcs	EAN13 inner	MASTER pcs
32250	8003438322500	cm. 50	10	8003438432254	10
32260	8003438322609	cm. 60	10	8003438432261	10
32270	8003438322708	cm. 70	10	8003438432278	10
32280	8003438322807	cm. 80	10	8003438432285	10

Righe parallele

Parallel rulers
Règles parallèles



Ref. 325SC

Art.	EAN13 art.	Descrizione / Description	INNER pcs	EAN13 inner	MASTER pcs
325SC	8003438325006	cm.30	1	8003438325006	5

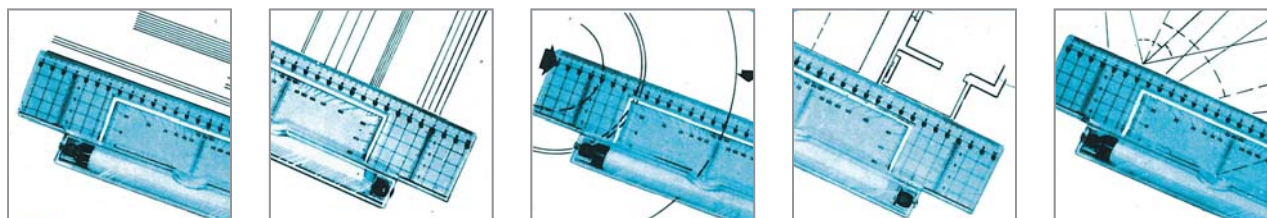

Coppia squadre + portamine 0,7 mm

Set of 2 squares + cluch pencil 0,7 mm
Couple 2 équerres + porte-mine 0,7 mm

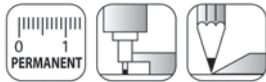

Smusso, tirachina e bordo interno
Bevelled edge, ink-edge and finger lift
Facette, bord anti-tache et bord intérieur

REUSE & PROTECT
SMART PACKAGING

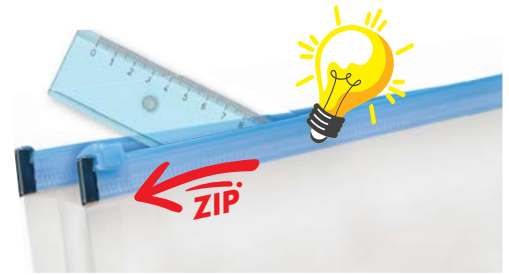

NEW

10
pcs



Ref. 70330ZIP

Art.	EAN13 art.	Descrizione / Description	INNER pcs	EAN13 inner	MASTER pcs
70330ZIP	8003438033635	Coppia squadre cm.30 + portamine 0,7	10	8003438033642	10

Coppia squadra

Set of 2 squares
Couple 2 équerres



Smusso, tirachina e bordo interno
Bevelled edge, ink-edge and finger lift
Facette, bord anti-tache et bord intérieur



**PUNTE
ARROTONDATE
DI SICUREZZA**

**ROUND EDGES
FOR SECURITY**

**BOUTS ROUNDS POUR
PLUS DE SÉCURITÉ**



ref. 70312SS
ref. 70315SS

ref. 70330SS
ref. 70335SS



Art.	EAN13 art.	Descrizione / Description	INNER pcs	EAN13 inner	MASTER pcs
70312SS	8003438703125	45° + 60° cm. 12	20	8003438723123	20
70315SS	8003438703156	45° + 60° cm. 15	20	8003438723154	20
70330SS	8003438703309	45° + 60° cm. 30	20	8003438723307	20
70335SS	8003438703354	45° + 60° cm. 35	20	8003438723352	20

Set disegno 4 pz

Drawing set 4 pcs
Set de traçage 4 pcs

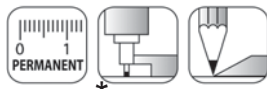

* eccetto goniometro
except protractor - sauf que rapporteur

Smusso, tirachina e bordo interno
Bevelled edge, ink-edge and finger lift
Facette, bord anti-tache et bord intérieur



Ref. 705

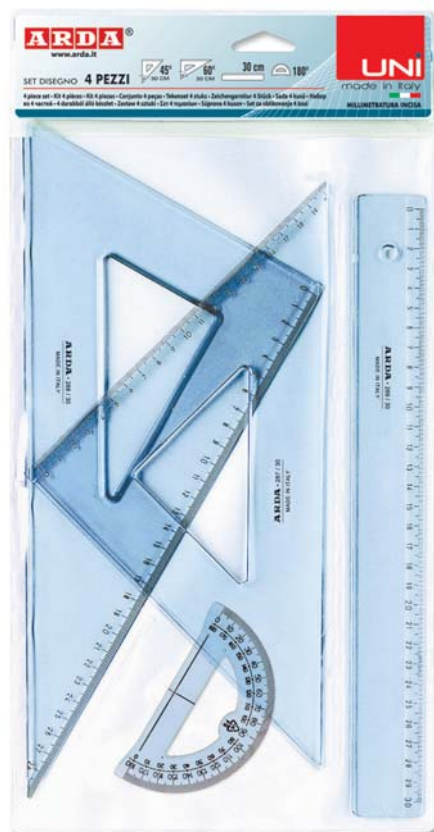

Ref. 70420SS - ref. 70430SS

Art.	EAN13 art.	Descrizione / Description	INNER pcs	EAN13 inner	MASTER pcs
705	8003438705006	Miniset: 45°- 60° cm.15 - R20 - 180°/10cm	20	8003438725004	20
70420SS	8003438704207	Set 4 pz/pcs: 45°- 60° cm.20 - R30 180°/10cm	10	8003438724205	10
70430SS	8003438704306	Set 4 pz/pcs: 45°- 60° cm.30 - R30 180°/10cm	20	8003438724304	20

Set disegno 4 pz

Drawing set 4 pcs
Set de traçage 4 pcs



* eccetto goniometro
except protractor - sauf que rapporteur

Art.	EAN13 art.	Descrizione / Description	INNER pcs	EAN13 inner	MASTER pcs
60420BIS	8003438604200	Set 4 pz : 45°- 60°cm.21+ R30 + 180°/10 cm	50	8003438009432	50

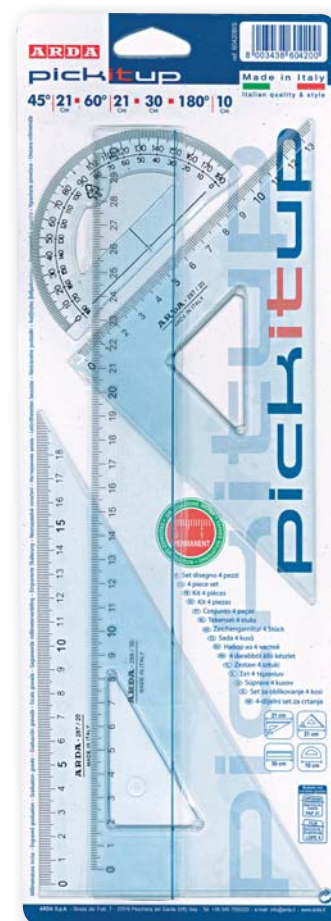

Ref. 60420BIS



**PUNTE
ARROTONDATE
DI SICUREZZA**

**ROUND EDGES
FOR SECURITY**

**BOUTS RONDS POUR
PLUS DE SECURITÉ**

Squadre geometriche

Geometric square
Equerre géométrique

4 funzioni in 1 - 4 functions in 1 - 4 usages en 1



45° cm 16

SENZA IMPUGNATURA

Without grip

Sans poignée

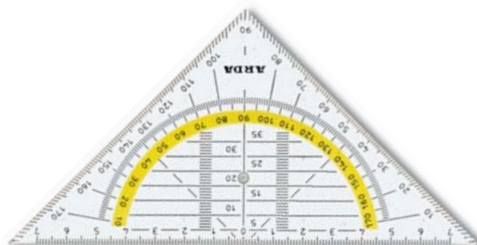

Ref. GEO300SS

Art.	EAN13 art.	Descrizione / Description	INNER pcs	EAN13 inner	MASTER pcs
GEO300SS	8003438003003	45° cm. 16 senza impugnatura	20	8003438413000	1000

45° cm 25

CON IMPUGNATURA FISSA

Fixed grip

Poignée fixée



Ref. GEO400PSS

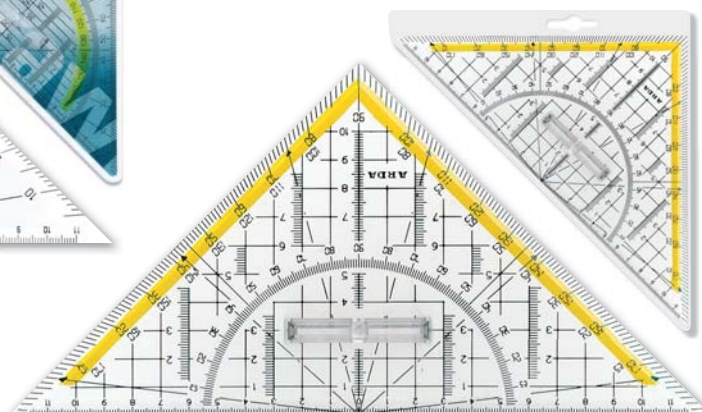

Ref. GEO400PQSS Quadrettata - With squared surface - Avec quadrillée

Art.	EAN13 art.	Descrizione / Description	INNER pcs	EAN13 inner	MASTER pcs
GEO400PSS	8003438014009	45° cm. 25 impugnatura fissa	10	8003438414007	140
GEO400PQSS	8003438008299	45° cm. 25 impugnatura fissa+quadrettatura	10	8003438008305	140

45° cm 25

CON IMPUGNATURA REMOVIBILE

With removable grip

Avec poignée amovibile

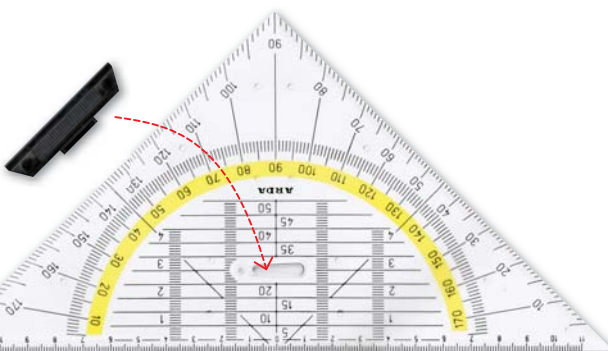

Ref. GEO401PSS

Art.	EAN13 art.	Descrizione / Description	INNER pcs	EAN13 inner	MASTER pcs
GEO401PSS	8003438024008	45° cm. 25 imp.removibile	10	8003438032140	100

Righe

Rulers - Règles



Smusso e tirachina
Bevelled edge and ink-edge
Facette et bord anti-tache



Ref. 28917



Ref. 28920S



Ref. S10130X



Ref. 28930S



Ref. 28940S



Ref. 50030S

Art.	EAN13 art.	Descrizione / Description	INNER pcs	EAN13 inner	MASTER pcs
28917	8003438289179	cm.17	150	8003438228918	150
28920S	8003438034120	cm.20	20	8003438033772	1500
S10130X	8003438002402	cm. 30 leggera - light - légère	50	8003438013675	1000
28930S	8003438034137	cm.30	20	8003438033796	780
50030S	8003438034205	cm.30 bianca - white - blanche	20	8003438034052	780
28940S	8003438034144	cm.40	20	8003438033819	300

Squadre

Set squares - Equerres

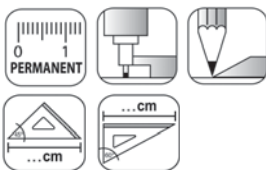

Smusso, tirachina e bordo interno
Bevelled edge, ink-edge and finger lift
Facette, bord anti-tache et bord intérieur

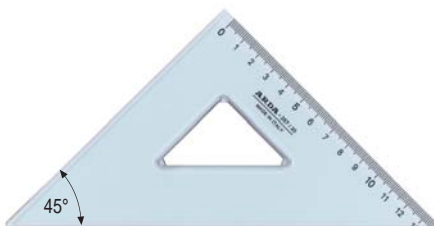

Ref. 28720S

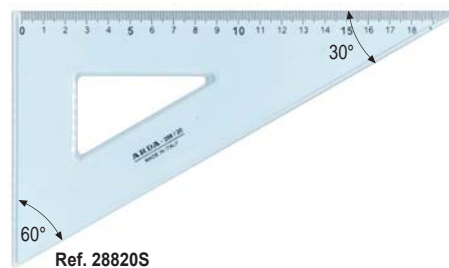

Ref. 28820S

Art.	EAN13 art.	Descrizione / Description	INNER pcs	EAN13 inner	MASTER pcs
28720S	8003438034175	45° cm 20	20	8003438033857	500
28820S	8003438034182	60° cm 20	20	8003438033871	500

Goniometri - Protractors - Rapporteurs

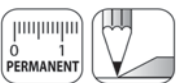

Smusso e bordo interno
Bevelled edge and finger lift
Facette et bord intérieur



Ref. 294S

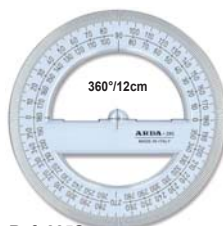

Ref. 285S

Art.	EAN13 art.	Descrizione / Description	INNER	EAN13 inner	MASTER
294S	8003438034151	180°cm10 con dec.	20	8003438021083	1200
285S	8003438034168	360°cm12	10	8003438033833	600

Squadra geometrica

Geometric square - Equerre géométrique



SENZA IMPUGNATURA
Without grip
Sans poignée

4 FUNZIONI IN 1 - 4 FUNCTIONS IN 1 - 4 USAGES EN 1

Art.	EAN13 art.	Descriz/Descr	INNER	EAN13 inner	MASTER
GEO300S	8003438034199	45°cm16	20	8003438033895	1260

Righelli quadri

Square rulers
Règles carrée



Ref. 77 15 cm ■ 7x7 mm



Ref. 50230C 30 cm ■ 8x12 mm



Art.	EAN13 art.	Descrizione / Description	INNER pcs	EAN13 inner	MASTER pcs
77	8003438770004	cm.15 - mm.7x7	250	8003438077004	250
50230C	8003438502308	cm. 30 - mm. 8x12	20	8003438450234	360

MANCINI - LEFT

La direzione giusta
per ogni mancino



Made
in Italy



Millimetratura speciale
per mancini : invertita da
destra verso sinistra.

FOR TECHNICAL AND SCHOOL USE

Special graduation for left-handers from right to left.

POUR EMPLOI TECHNIQUE ET SCOLAIRE.

Graduation spéciale pour gauchers de droit à gauche.

MADE IN ITALY
ITALIAN QUALITY & STYLE



Squadre

Set square - Equerre

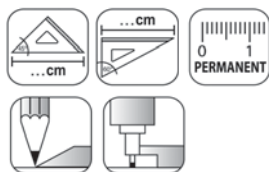

Smusso, tirachina e bordo interno
Bevelled edge, ink-edge and finger lift
Facette, bord anti-tache et bord intérieur

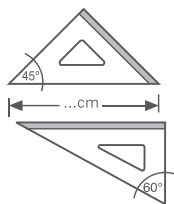

**PUNTE
ARROTONDATE
DI SICUREZZA**

**ROUND EDGES
FOR SECURITY**

**BOUTS RONDS POUR
PLUS DE SECURITÉ**

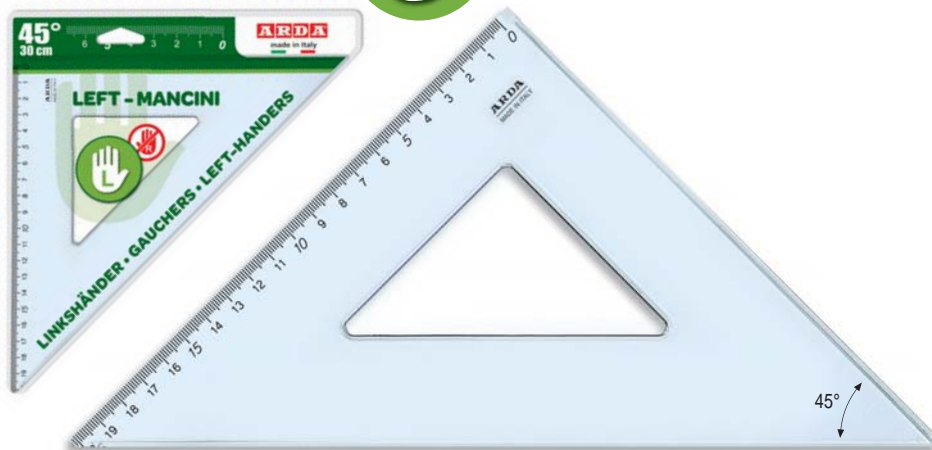

Ref. 28720MAN - 28730MAN



Ref. 28820MAN - 28830MAN

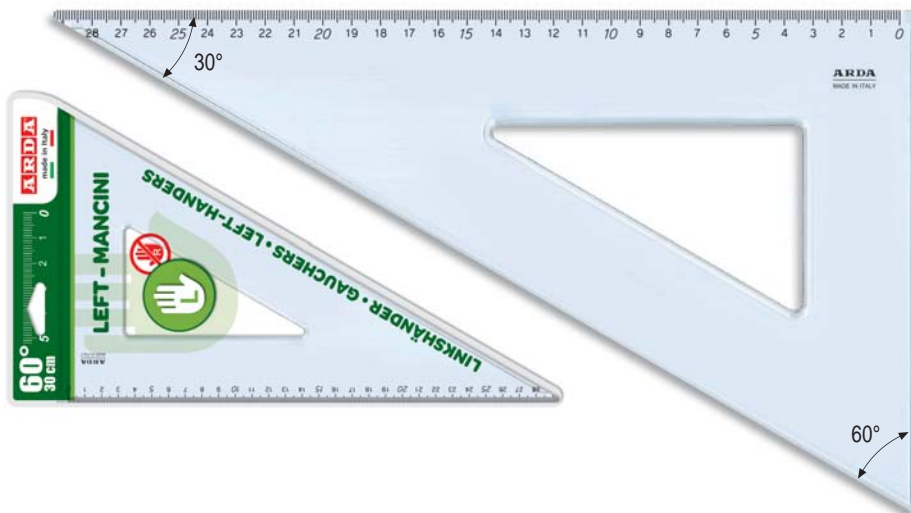

Art.	EAN13 art.	Descrizione / Description	INNER pcs	EAN13 inner	MASTER pcs
28720MAN	8003438002495	45° cm. 20	10	8003438007537	10
28820MAN	8003438002518	60° cm. 20	10	8003438007544	10
28730MAN	8003438021618	45° cm. 30	10	8003438021663	10
28830MAN	8003438021625	60° cm. 30	10	8003438021670	10

Righe

Rulers - Règles



Smusso e tirachina
Bevelled edge and ink-edge
Facette et bord anti-tache



Ref. 28917MAN - 28930MAN - 28950MAN



Art.	EAN13 art.	Descrizione / Description	INNER pcs	EAN13 inner	MASTER pcs
28917MAN	8003438021649	cm 17	10	8003438021694	10
28930MAN	8003438006899	cm 30	10	8003438007551	10
28950MAN	8003438021595	cm 50	10	8003438021656	10



Doppio decimetro

Finger grip ruler 20 cm
Double décimètre

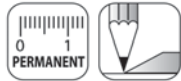

Ref. 283MAN



2 millimetrature. Impugnatura corta.
2 graduations. Short grip.
2 graduations. Poignée courte.

Art.	EAN13 art.	Descrizione / Description	INNER pz/pcs	EAN13 inner	MASTER pz/pcs
283MAN	8003438021632	cm. 20	10	8003438021687	10

Set disegno 3 pz.

Drawing set 3 pcs - Set de traçage 3 pcs



Smusso e tirachina
Bevelled edge and ink-edge
Facette et bord anti-tache

Art.	EAN13 art. 8003438...	Descrizione / Description	INNER pz/pcs	EAN13 inner 8003438...	MASTER pz/pcs
70420MAN	...002471	R30 + 45°/20 cm + 60°/20 cm	25	...007797	25
704303MAN	...022356	R30 + 45°/30 cm + 60°/30 cm	20	...022363	20



Ref. 70420MAN



Ref. 704303MAN



70
pcs

Ref. 4766MAN
32,5 x 25 x 57 h. cm

Espositore da banco in cartone

Carton desktop display
Presentoir de comptoir en carton

DISPLAY 70 pz / pcs

Art.	EAN13 art.	Descrizione / Description	INNER	MASTER
4766MAN	8003438 021724	10x Sq. 45° cm.30 - ref.28730MAN 10x Sq. 60° cm.30 - ref.28830MAN 10x Righello cm.17 - ref.28917MAN 10x Righe cm.30 - ref. 28930MAN 10x Righe cm.50 - ref.28950MAN 10x Set 3 pz. - ref.70420MAN 10x Doppio dec. - ref. 283MAN	1	1

Disponibilità limitata alle campagne promozionali - Product availability limited to promotional campaigns - Disponibilité limitée aux campagnes promotionnelles

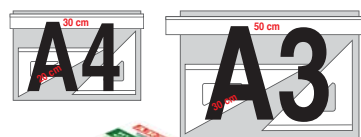

Contenuto per disegno tecnico
su fogli A4 e A3
Content for technical drawing
on A4 and A3 sheets
Contenu pour le dessin
technique sur papier A4 et A3



Temperamatite PER MANCINI

Sharpener for left-handers
 Taille-crayons pour gauchers

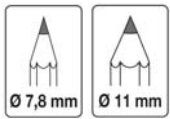

Ref. TE803MANSC
 Display 8 pcs



Art.	EAN13 art.	Descrizione / Description	INNER pcs	EAN13 inner	MASTER pcs
TE803MANSC	8003438030368	in display 8 pz/pcs (ean display 8003438030375)	8 (1 display)	8003438030375	96 (12 display)

Forbici PER MANCINI

Scissors for left-handers - Ciseaux pour gauchers

Autentiche forbici per mancini, con lame a molatura speculare. Impugnatura in ABS.
 Real left-hand scissors, with specular blades : ABS grip.
 Veritables ciseaux pour gaucher, avec lames inversées. Poignée ABS.



LEFT cm. 13

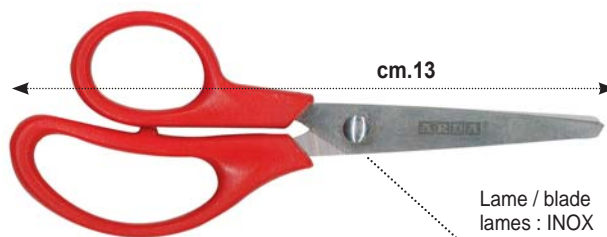

Ref. FA1206



Ref. FA1206SF
 20 pz / pcs



Art.	EAN13 art.	Descrizione / Description	INNER pcs	EAN13 inner	MASTER pcs
FA1206	8003438011169	in blister	10	8003438011565	100
FA1206SF	8003438032522	sfusa / bulk / vrac	20 (1 display)	8003438032539	200

LEFT cm. 17

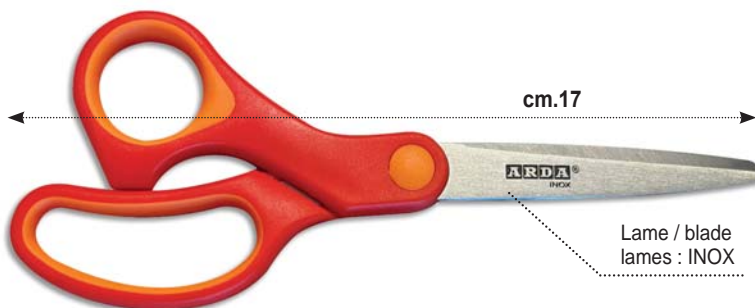

Ref. FB1306

Art.	EAN13 art.	Descrizione / Description	INNER pcs	EAN13 inner	MASTER pcs
FB1306	8003438033284	in blister	10	8003438033291	100

ECCELLENTE RAPPORTO QUALITÀ / PREZZO.

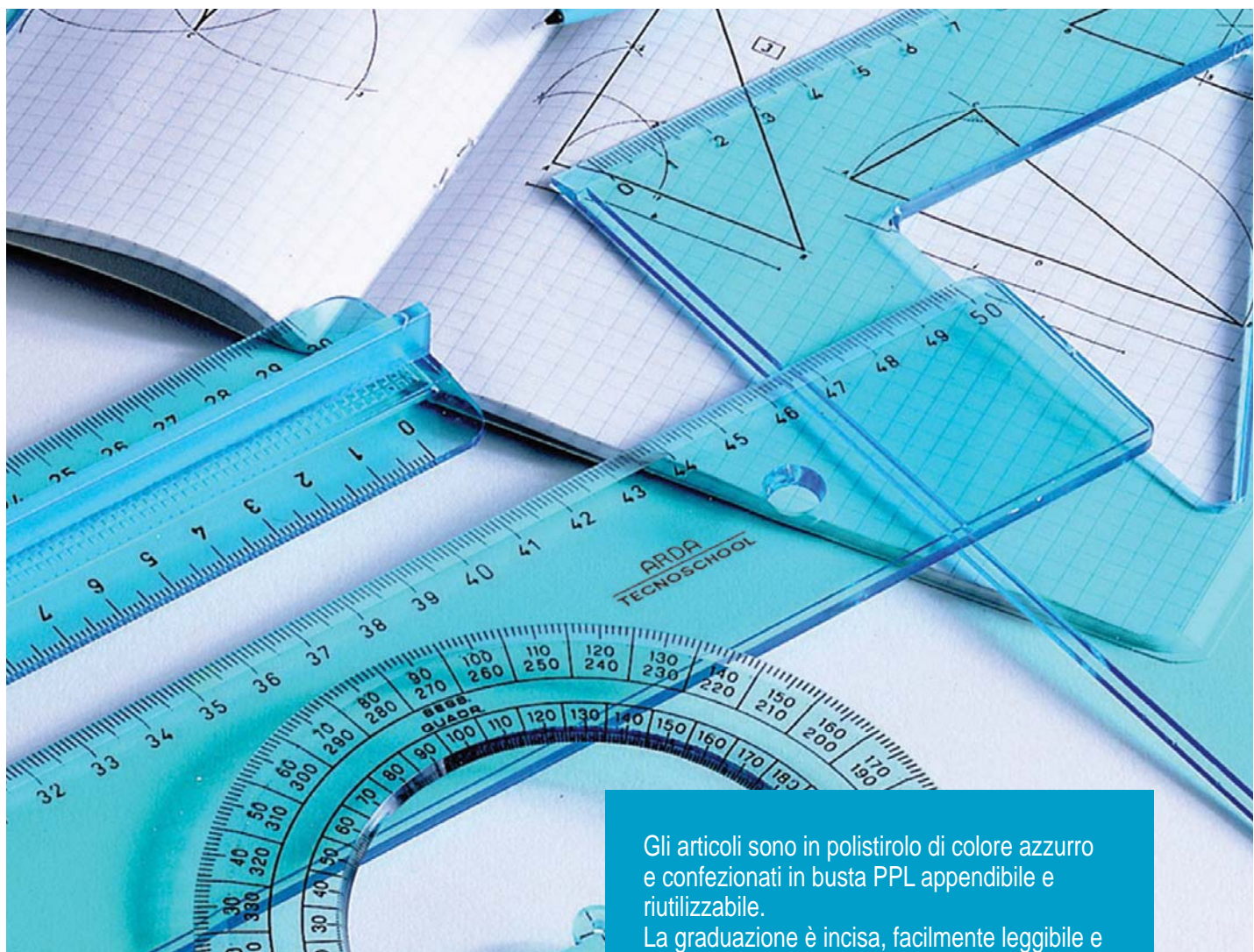

Gli articoli sono in polistirolo di colore azzurro e confezionati in busta PPL appendibile e riutilizzabile.

La graduazione è incisa, facilmente leggibile e molto precisa.

EXCELLENT VALUE FOR MONEY.

The articles are made of polystyrene, blue colour and packaged individually in a reusable PPL wallet with hang tab. Etched easy-to-read graduation with a high level of accuracy.

UN RAPPORT EXCELLENT ENTRE PRIX ET QUALITÉ.

Les articles sont en polystyrene en couleur bleu et en pochette PPL accrochable et réutilisable. La graduation est gravée à chaud avec un standard de précision et lisibilité très élevé.

MADE IN ITALY
ITALIAN QUALITY & STYLE

Squadre

Set square - Equerre



Smusso, tirachina e bordo interno
Bevelled edge, ink-edge and finger lift
Facette, bord anti-tache et bord intérieur

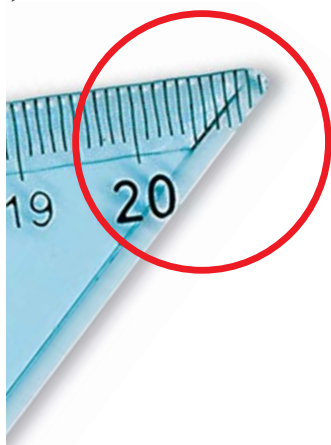
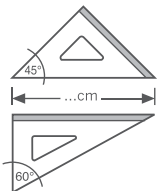

PUNTE ARROTONDATE DI SICUREZZA

ROUND EDGES FOR SECURITY

BOUTS ROUNDS POUR PLUS DE SECURITÉ

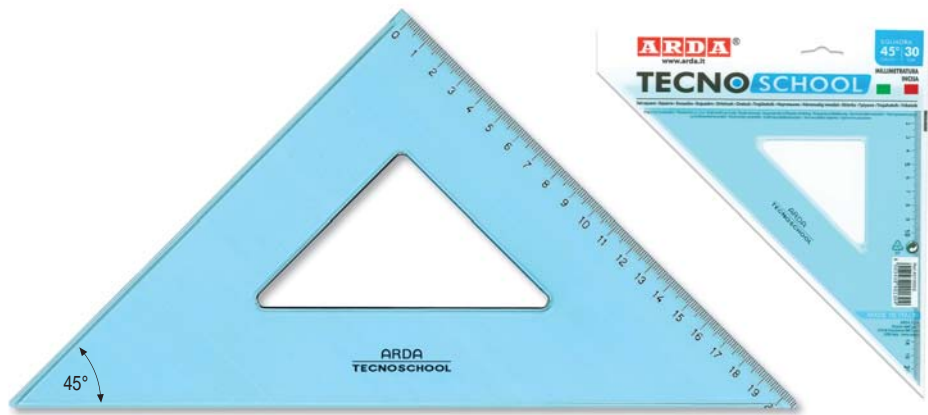

Ref. 40115 - 20 - 25 - 30 - 35 SS

Art.	EAN13 art.	Descrizione / Description	INNER pcs	EAN13 inner	MASTER pcs
40115SS	8003438401151	45° cm. 15	20	8003438421159	900
40120SS	8003438401205	45° cm. 20	20	8003438421203	400
40125SS	8003438401250	45° cm. 25	20	8003438421258	300
40130SS	8003438401304	45° cm. 30	20	8003438421302	200
40135SS	8003438401359	45° cm. 35	20	8003438421357	160

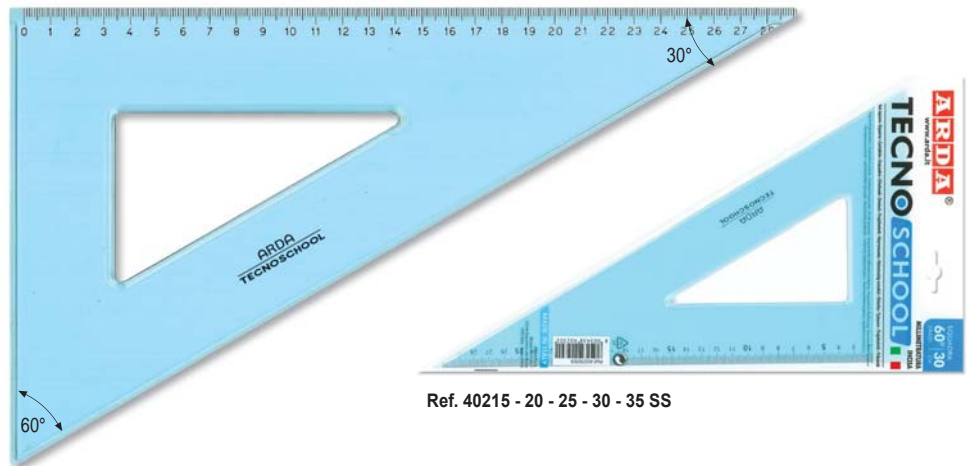

Ref. 40215 - 20 - 25 - 30 - 35 SS

Art.	EAN13 art.	Descrizione / Description	INNER pcs	EAN13 inner	MASTER pcs
40215SS	8003438402158	60° cm. 15	20	8003438422156	880
40220SS	8003438442208	60° cm. 20	20	8003438422200	400
40225SS	8003438402257	60° cm. 25	20	8003438422255	260
40230SS	8003438402301	60° cm. 30	20	8003438422309	200
40235SS	8003438402356	60° cm. 35	20	8003438422354	200

Righe

Rulers - Règles



Smusso e tirachina
Bevelled edge and ink-edge
Facette et bord anti-tache



Ref. 40020 - 30 - 40 - 50 - 60 SS



Art.	EAN13 art.	Descrizione / Description	INNER pcs	EAN13 inner	MASTER pcs
40020SS	8003438400208	cm. 20	20	8003438420206	700
40030SS	8003438400307	cm. 30	20	8003438420305	400
40040SS	8003438400406	cm. 40	20	8003438420404	200
40050SS	8003438400505	cm. 50	20	8003438420503	200
40060SS	8003438400604	cm. 60	20	8003438420602	200

Doppio e Triplo decimetro

Finger grip ruler 20-30cm
Double e triple décimètre

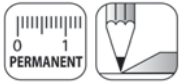

2 millimetrature. Impugnatura corta.
2 graduations. Short grip.
2 graduations. Poignée corte.

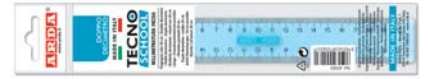

Ref. 403SS



Ref. 406SS

Art.	EAN13 art.	Descrizione / Description	INNER pcs	EAN13 inner	MASTER pcs
403SS	8003438004031	cm. 20	20	8003438104038	300
406SS	8003438004062	cm. 30	20	8003438104069	160

Goniometri

Protractor - Rapporteur

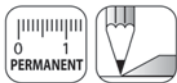

Smusso e bordo interno
Bevelled edge and finger lift
Facette et bord intérieur



Ref. 404SS

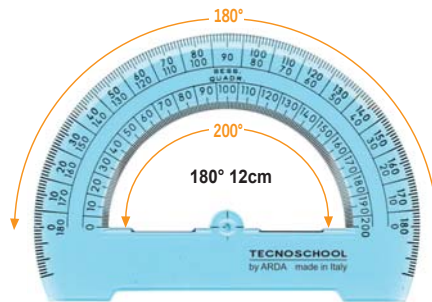

Ref. 407SS

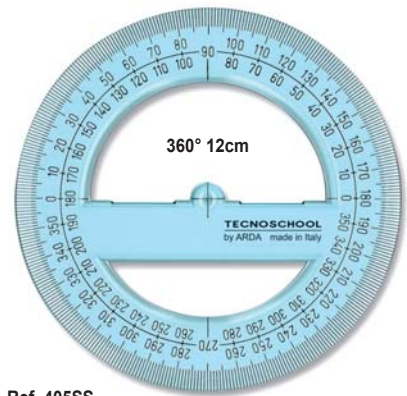

Ref. 405SS



Art.	EAN13 art.	Descrizione / Description	INNER pcs	EAN13 inner	MASTER pcs
404SS	8003438004048	180° cm.10	20	8003438104045	900
407SS	8003438004079	180° cm.12	20	8003438104076	660
405SS	8003438004055	360° cm.12	20	8003438104052	480

Curvilinee

French curves - Set de 3 pistolets



Con doppio tirachina
With double ink-edge
Double bord anti-tache

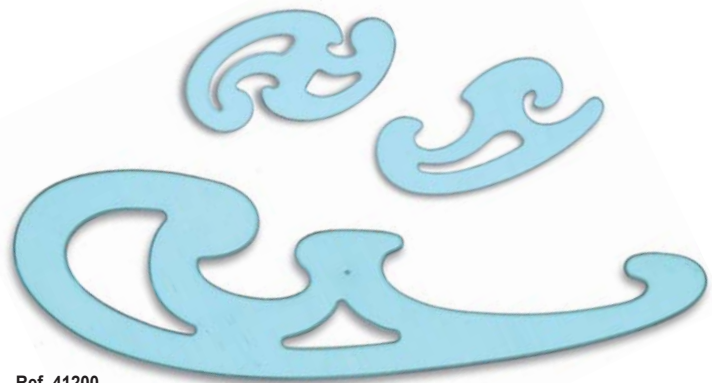

Ref. 41200

Art.	EAN13 art.	Descrizione / Description	INNER pcs	EAN13 inner	MASTER pcs
41200	8003438412003	Set 3 pz curvilinee/french curves/pistolets	10	8003438412027	190

Set disegno

Drawing set
Set de traçage



REUSE & PROTECT
SMART PACKAGING



*
* eccetto goniometro
except protractor
sauf que rapporteur

Smusso, tirachina e bordo interno
Bevelled edge, ink-edge and finger lift
Facette, bord anti-tache et bord
intérieur



Ref. 60430ZIP



25
pcs

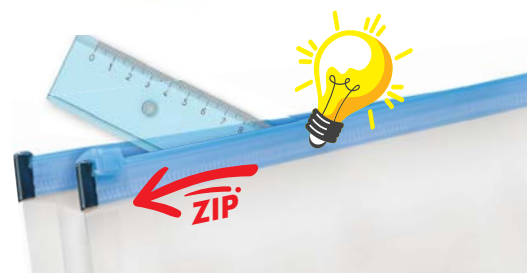

Art.	EAN13 art.	Descrizione / Description	INNER pcs	EAN13 inner	MASTER pcs
60430ZIP	8003438033031	Set 4 pz/pcs in smart pack: 45°cm 30 - 60°cm.30 - R30 - 360° cm12	25	8003438033055	25

Set disegno

Drawing set
Set de traçage



*
* eccetto goniometro
except protractor
sauf que rapporteur

Smusso, tirachina e
bordo interno
Bevelled edge, ink-edge
and finger lift
Facette, bord anti-tache
et bord intérieur



Ref. 7063



Ref. 706

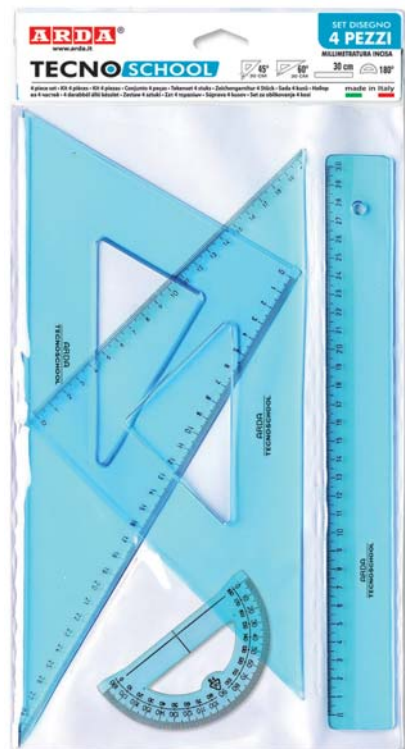

Ref. 60430SS

PUNTE ARROTONDATE DI SICUREZZA
ROUND EDGES FOR SECURITY
BOUTS ROUNDS POUR PLUS DE SÉCURITÉ

Art.	EAN13 art.	Descrizione / Description	INNER pcs	EAN13 inner	MASTER pcs
706	8003438706003	Miniset 4 pz: 45°- 60° cm.15 - R20 - 180°/10cm	20	8003438726001	20
7063	8003438013835	Miniset 3 pz: 45°- 60° cm.15 - R17	20	8003438013842	20
60430SS	8003438604309	Set 4 pz/pcs: 45°- 60° cm.30 - R30 180°/10cm	20	8003438624307	20

Coppia Squadre

Set of 2 squares - Pochette 2 équerres

ref. 60330SS
ref. 60335SS



Smusso, tirachina e bordo interno
Bevelled edge, ink-edge and finger lift
Facette, bord anti-tache et bord intérieur

Art.	EAN13 art.	Descrizione / Description	INNER pcs	EAN13 inner	MASTER pcs
60330SS	8003438603302	45° + 60°cm. 30	20	8003438623300	20
60335SS	8003438603357	45° + 60°cm. 35	20	8003438623355	20

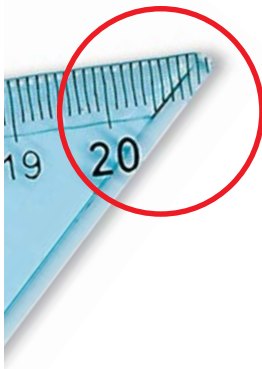

PUNTE ARROTONDATE DI SICUREZZA
ROUND EDGES FOR SECURITY
BOUTS ROUNDS POUR PLUS DE SECURITÉ

Espositore da banco in metallo

Desktop metal display
Presentoir de comptoir en metal

200
pcs

DISPLAY 200 pz / pcs

Art.	EAN13 art.	Descrizione / Description	INNER	MASTER
6640	8003438664006	20x Sq. 45° cm.30 - ref.40130SS 20x Sq. 60° cm.30 - ref.40230SS 20x Sq. 45° cm.35 - ref.40135SS 20x Sq. 60° cm.35 - ref.40235SS 20x Righe cm.50 - ref.40050SS 20x Righe cm.60 - ref.40060SS 20x Doppio dec. cm.20 - ref.403SS 20x Triplo dec. cm.30 - ref.406SS 20x Gon. 180°cm.10 - ref. 404SS 20x Gon. 360°cm.12 - ref. 405SS	1	1

Disponibilità limitata alle campagne promozionali - Product availability limited to promotional campaigns - Disponibilité limitée aux campagnes promotionnelles



Contenuto specifico per disegno tecnico su fogli A3
Specific content for technical drawing on A3 sheets
Contenu spécifique pour le dessin technique sur papier A3

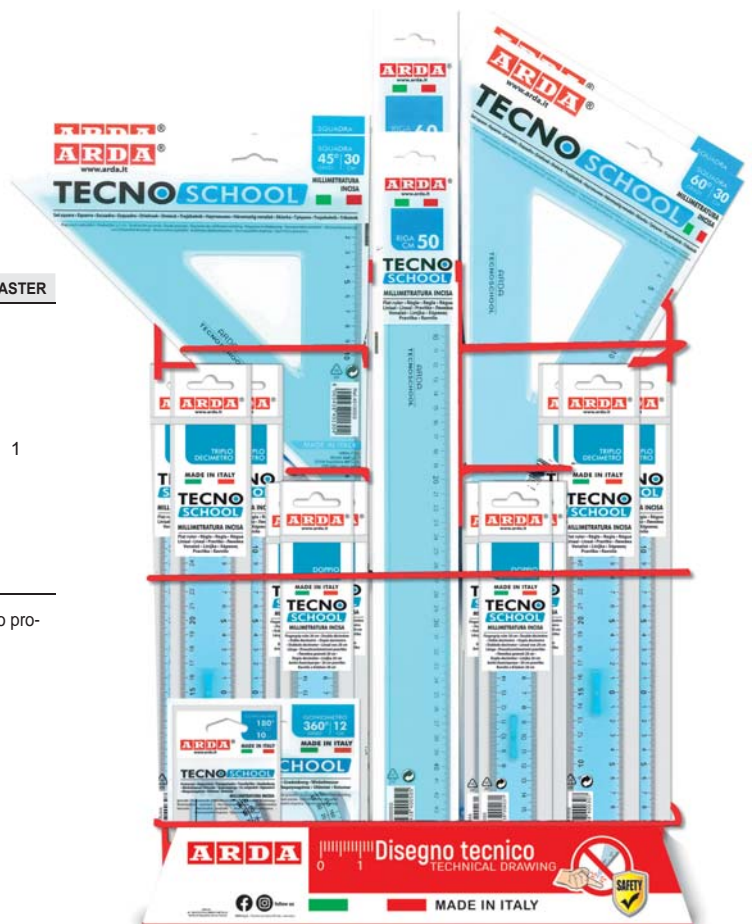

Ref. 6640
39.5 x 19 x 63 h. cm

Righe e miniset disegno

Rulers and drawing minikit
Règles et minikit de traçage



Smusso e tirachina
Bevelled edge and ink-edge
Facette et bord anti-tache

FLUO
colours

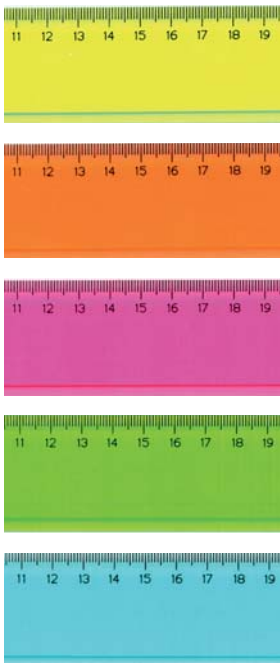

Ref. 40030FLAS



Ref. 40016FLAS

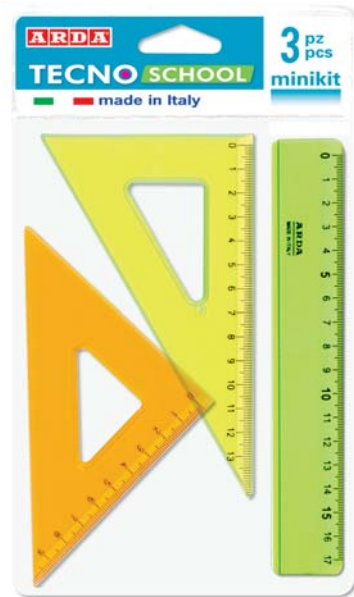

Ref. 7063FL

Art.	EAN13 art.	Descrizione / Description	INNER pcs	EAN13 inner	MASTER pcs
40016FLAS	8003438019264	Riga / Ruler / Règle cm.17	20	8003438019271	800
40030FLAS	8003438019097	Riga / Ruler / Règle cm.30	20	8003438019165	20
7063FL	8003438019134	Miniset 3 pz./pcs : 45°cm15 + 60°cm15 + R17 cm	20	8003438019196	20

Colori assortiti - Assorted colours - Couleurs assorties



Ref. 704/12/4BL



Art.	EAN13 art.	Descrizione / Description	INNER pcs	EAN13 inner	MASTER pcs
704/12/4BL	8003438001924	MINI PICKITUP set 4 pz : 45°/12 cm + 60° 12cm + R15 + 180° 10 cm	25	8003438031617	300

Colori assortiti - Assorted colours - Couleurs assorties

**Barattolo 50 righelli
modello stretto**

Pot containing 50 rulers - narrow
Pot de 50 règles - étroites

15 cm

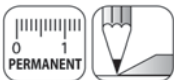

50
pcs

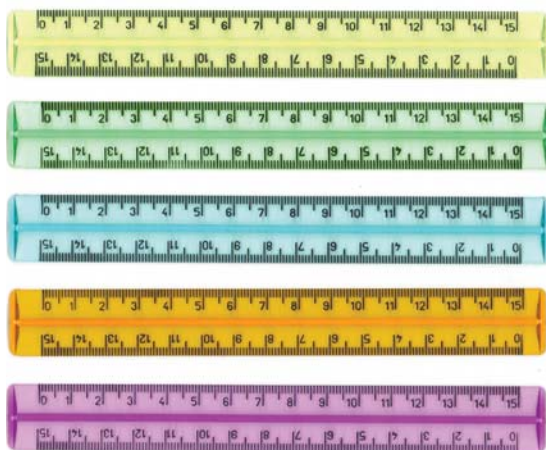

Ref. 282C

Art.	EAN13 art.	Descrizione / Description	INNER pcs	EAN13 inner	MASTER pcs
282C	8003438002822	cm. 15	1	8003438002822	20

colori assortiti - assorted colours - couleurs assorties

**Barattolo 50 righelli
modello stretto**

Pot containing 50 rulers - narrow
Pot de 50 règles - étroites

15 cm



50
pcs



Ref. 282FL

Art.	EAN13 art.	Descrizione / Description	INNER pcs	EAN13 inner	MASTER pcs
282FL	8003438026101	cm. 15	1	8003438026101	20

colori assortiti - assorted colours - couleurs assorties

Barattolo 30 righelli modello largo

Pot containing 30 rulers - large
Pot de 30 règles - larges

17 cm

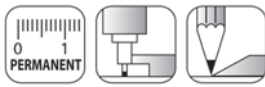

30
pcs

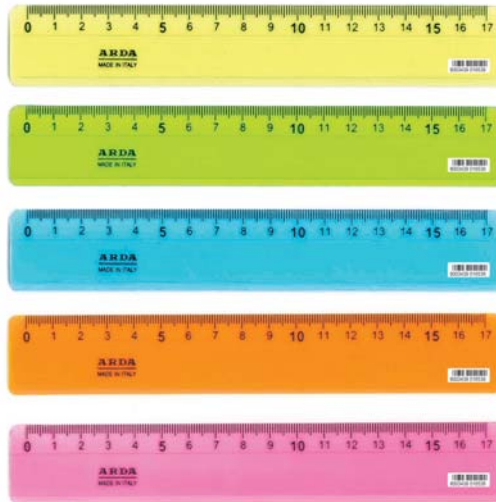

Ref. 28917BAR

Art.	EAN13 art.	Descrizione / Description	INNER pcs	EAN13 inner	MASTER pcs
28917BAR	8003438289186	cm.17	1	8003438289186	20

Articolo singolo / Each articles / Article à l'unité : 8003438 016539
colori assortiti - assorted colours - couleurs assorties

Barattolo 10 doppi decimetri

Pot containing 10 finger grip rulers 20 cm
Pot de 10 double décimètre

20 cm

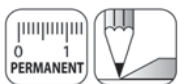

10
pcs

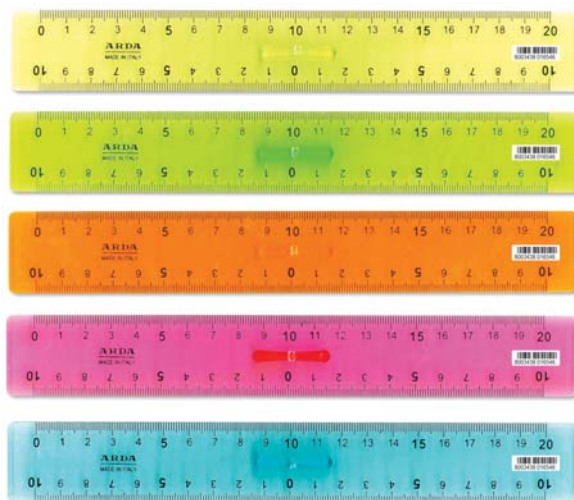

Ref. 283BAR

Art.	EAN13 art.	Descrizione / Description	INNER pcs	EAN13 inner	MASTER pcs
283BAR	8003438012838	cm.20	1	8003438012838	10

Articolo singolo / Each articles / Article à l'unité : 8003438 016546
colori assortiti - assorted colours - couleurs assorties

#KEEP COLOUR



A WORLD OF COLORS
UN MONDE DE COULEURS

UN MONDO
DI COLORI

MADE IN ITALY
ITALIAN QUALITY & STYLE

Squadre 45° e 60°

Set square 45° and 60°
Equerre 45° et 60°

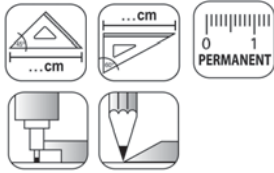

Smusso, tirachina e bordo interno
Bevelled edge, ink-edge and finger lift
Facette, bord anti-tache et bord intérieur



Ref. KCP4530

Art.	EAN13 art.	Descrizione / Description	INNER pcs	EAN13 inner	MASTER pcs
KCP4530	8003438022578	45° cm.30	10	8003438022646	10

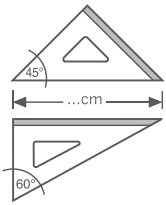

**PUNTE
ARROTONDATE
DI SICUREZZA**

**ROUND EDGES
FOR SECURITY**

**BOUTS RONDS POUR
PLUS DE SÉCURITÉ**

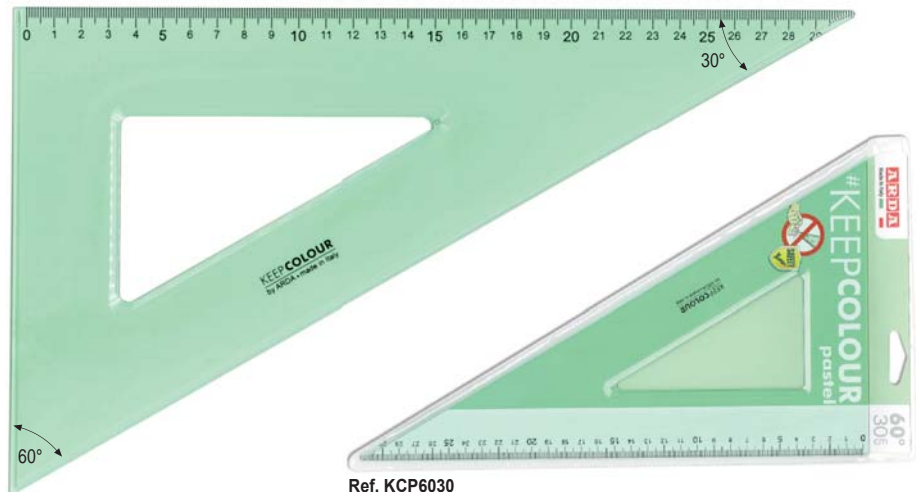

Ref. KCP6030

Art.	EAN13 art.	Descrizione / Description	INNER pcs	EAN13 inner	MASTER pcs
KCP6030	8003438022585	60° cm.30	10	8003438022653	10

Righe

Rulers
Règles



Ref. KCP50



Smusso e tirachina
Bevelled edge and ink-edge
Facette et bord anti-tache



Art.	EAN13 art.	Descrizione / Description	INNER pcs	EAN13 inner	MASTER pcs
KCP50	8003438022592	cm.50	10	8003438022660	10

Doppi e Tripli decimetri

Finger grip ruler 20-30cm
Double e triple décimètre

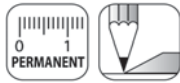

2 millimetrature. Impugnatura corta
2 graduations. Short grip
2 graduations. Poignée courte



Ref. KCP20P



Ref. KCP30P

Art.	EAN13 art.	Descrizione / Description	INNER pcs	EAN13 inner	MASTER pcs
KCP20P	8003438022608	cm.20	10	8003438022677	10
KCP30P	8003438022615	cm.30	10	8003438022684	10

Goniometro 180°

Protractor 180°
Rapporteur 180°

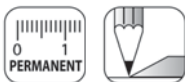

Smusso e bordo interno
Bevelled edge and finger lift
Facette et bord intérieur



Ref. KCP18012



Art.	EAN13 art.	Descrizione / Description	INNER pcs	EAN13 inner	MASTER pcs
KCP18012	8003438028761	180° cm.12	10	8003438028778	10

Goniometro 360°

Protractor 360°
Rapporteur 360°

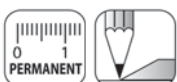

Smusso e bordo interno
Bevelled edge and finger lift
Facette et bord intérieur

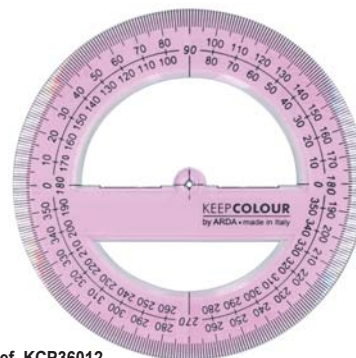

Ref. KCP36012



Art.	EAN13 art.	Descrizione / Description	INNER pcs	EAN13 inner	MASTER pcs
KCP36012	8003438022622	360° cm.12	10	8003438022691	10

Squadra geometrica

Geometric square - Equerre géométrique

4 FUNZIONI IN 1
4 FUNCTIONS IN 1 - 4 USAGES EN 1

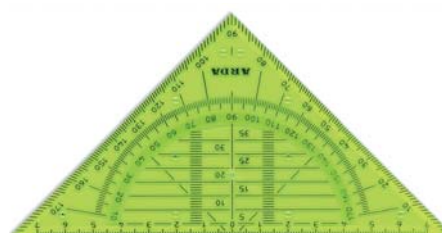
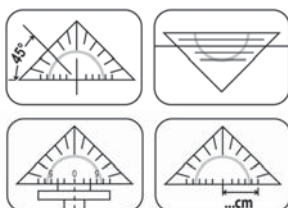

Ref. KCGEO300



Art.	EAN13 art.	Descrizione / Description	INNER pcs	EAN13 inner	MASTER pcs
KCGEO300	8003438018724	45° cm.16	10	8003438018762	350

Espositore da banco in cartone

Carton desktop display - Presentoir de comptoir en carton



100
pcs

DISPLAY 100 pz / pcs

Art.	EAN13 art.	Descrizione / Description	INNER	MASTER
KCP4766	8003438022561	20x Sq. 45°cm.30 - ref.KCP4530 20x Sq. 60°cm.30 - ref. KCP6030 20x Righe cm.50 - ref. KCP50 10x Doppio dec. cm.20 - ref. KCP20P 10x Triplo dec. cm.30 - ref. KCP30P 20x Gon. 360°cm.12 - ref. KCP36012	1	1

Disponibilità limitata alle campagne promozionali
Product availability limited to promotional campaigns



Contenuto specifico per disegno tecnico su fogli A3
Specific content for technical drawing on A3 sheets
Contenu spécifique pour le dessin technique sur papier A3

Ref. KCP4766
32,5 x 25 x 57 h. cm

Miniset disegno 3 pezzi

Drawing minikit 3 pcs
Miniset de traçage 3 pcs



Smusso e tirachina
Bevelled edge and ink-edge
Facette et bord anti-tache



PUNTE ARROTONDATE DI SICUREZZA
ROUND EDGES FOR SECURITY

BOUTS ROUNDS POUR
PLUS DE SÉCURITÉ



Ref. KCP7063DSS

Art.	EAN13 art.	Descrizione / Description	INNER pcs	EAN13 inner	MASTER pcs
KCP7063DSS	8003438 022530	Miniset 3 pcs : 45°cm.15 + 60°cm.15 + R16	20	8003438 022028	20

Barattolo 24 righelli

Pot containing 24 rulers
Pot de 24 règle

16 cm

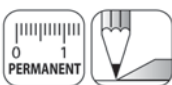

Smusso e tirachina
Bevelled edge and ink-edge
Facette et bord anti-tache

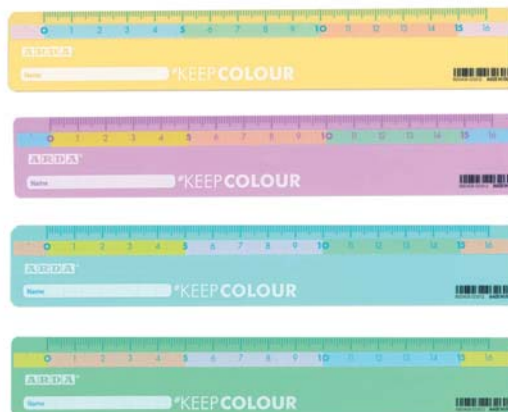

24
pcs

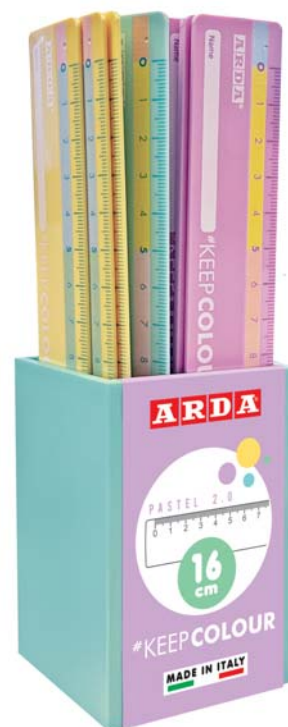

Ref. R17PBAR

Art.	EAN13 art.	Descrizione / Description	INNER pcs	EAN13 inner	MASTER pcs
R17PBAR	8003438033529	cm.16	1	8003438033529	10

Articolo singolo / Each articles / Article à l'unité : 8003438 033512

Espositore 48 righelli

Display 48 rulers
Presentoir 48 règles

16 cm



Smusso e tirachina
Bevelled edge and ink-edge
Facette et bord anti-tache



48
pcs

Ref. KCP17DESP
24,6 x 6,7 x 19 h. cm



Art.	EAN13 art.	Descrizione / Description	INNER pcs	EAN13 inner	MASTER pcs
KCP17DESP	8003438 022547	Display 48 pz - R16 cm	1	8003438 022547	1

Articolo singolo / Each articles / Article à l'unité : 8003438 022554

Set disegno in busta porta album

Drawing set in album holder envelope
Set de traçage dans une enveloppe porte papier à dessin

Custodia con gli articoli indispensabili per il disegno tecnico. Per ogni pezzo è prevista la sua sede e sul retro è prevista una tasca nella quale riporre l'album da disegno. Busta disponibile in 3 colori assortiti.

Smart case with essential items for technical drawing. For each piece there is its own place and on the back there is a pocket in which to store the sketchbook. Case in 3 fluo assorted colours.

Pochette avec les essentiels pour le dessin technique. Pour chaque pièce, il y a son propre siège et à l'arrière il y a une poche dans laquelle ranger le papier à dessin. Pochette en 3 couleurs assorties.

album non incluso
album not included
papier à dessin non inclus



DISEGNO
DRAWING

Art.	EAN13 art.	Descrizione / Description	INNER pcs	EAN13 inner	MASTER pcs
KC60430	8003438028198	Set disegno 4 pz/pcs in busta porta album : 45°cm.30 + 60°cm.30 + R30 + 360° cm.12	10	8003438028235	10

Miniset disegno in busta con zip

Drawing miniset in bag with zip
Miniset de traçage in pochette avec zip



FORATURA UNIVERSALE
MULTI PUNCHES
PERÇAGE UNIVERSEL

Art.	EAN13 art.	Descrizione / Description	INNER pcs	EAN13 inner	MASTER pcs
KC7063	8003438028181	Miniset 3 pz/pcs : 45°cm.15 + 60°cm.15 + R16	10	8003438028228	10

Left & Right

Doppia graduazione. Ideale anche per mancini.
 Double graduation. Also ideal for left-handed people.
 Double graduation. Idéal également pour les gauchers.



Espositori da banco

Desktop displays
 Presentoir de comptoir

15
pcs



Ref. 115ESP
 11,7 x 10,5 x 23 h. cm

45
pcs



Ref. 117ESP
 23,8 x 15 x 44,5 h. cm

Art.	EAN13 art.	Descrizione / Description	INNER pcs	EAN13 inner	MASTER pcs
115ESP	8003438029355	Display 15 righelli/rulers/règles cm.15 (ean pcs 8003438 029324)	1	8003438029355	1
117ESP	8003438030634	Display 45 pz/pcs : 15x miniset + 15x R15cm + 15x R30 cm	1	8003438030634	1

Colori assortiti - Assorted colours - Couleurs assorties

Righe

Rulers - Règles



FACILE
DA
SOLLEVARE
Easy to
pick-up



Ref. 115

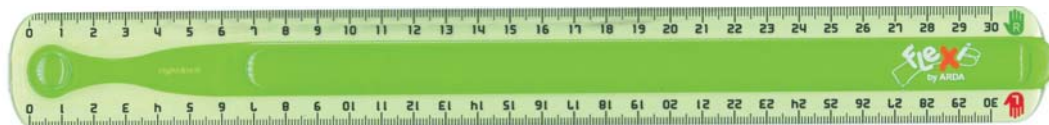

Ref. 130



Art.	EAN13 art.	Descrizione / Description	INNER pcs	EAN13 inner	MASTER pcs
115	8003438029324	Riga FLEXI cm.15 Left&Right	15	8003438029331	300
130	8003438030405	Riga FLEXI cm.30 Left&Right	15	8003438030429	300

Colori assortiti - Assorted colours - Couleurs assorties

Miniset disegno 3 pz

Drawing miniset 3 pcs

Miniset de traçage 3 pcs

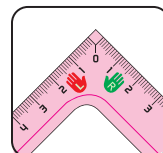
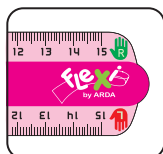

Ref. 131



Art.	EAN13 art.	Descrizione / Description	INNER pcs	EAN13 inner	MASTER pcs
131	8003438030412	Miniset 3 pz/pcs : R15 + 60°cm15+180°cm10	15	8003438030436	300

Colori assortiti - Assorted colours - Couleurs assorties

Maschere e normografi

Lettering stencils, templates - Gabarits et normographe

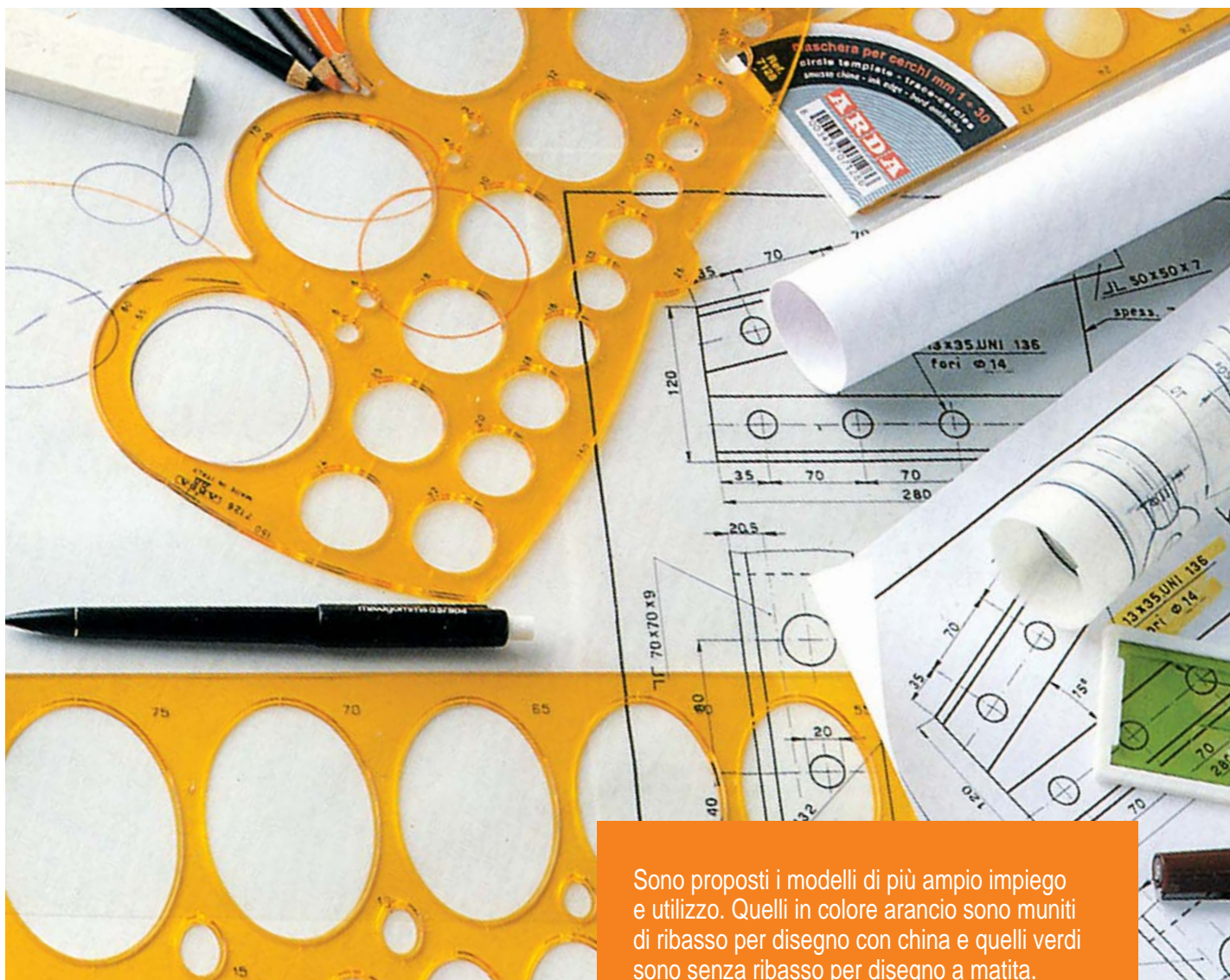

Sono proposti i modelli di più ampio impiego e utilizzo. Quelli in colore arancio sono muniti di ribasso per disegno con china e quelli verdi sono senza ribasso per disegno a matita. I normografi sono adatti per scrivere con la matita o con la china e sono disponibili con caratteri norme UNI e ISO. Le righe normografiche e le normosfere si utilizzano con penna a sfera.

The range includes the most widely-used models. The orange articles have inking edges for ink drawings, while the green articles are not bevelled and are designed for pencil drawings. The lettering stencils are suitable for use with ink and pencil and are available with characters respecting ISO and UNI standards. The rulers with lettering stencils incorporated can also be used with ballpoint pens.

Dans cette gamme il y a une sélection des modèles les plus utilisés. Les modèles en couleur ocre ont le bord-antitache pour le dessin à chine tandis que ceux en couleur vert n'en sont pas fournis car ils sont utilisés pour le dessin à crayon.

Les normographe sont utilisables soit avec la chine, soit avec le crayon. Ils sont disponibles selon les normes ISO et les normes UNI aussi. Les règles normographe et les trace-lettres peuvent être utilisés avec le stylo bille.

MADE IN ITALY

 ITALIAN QUALITY & STYLE

Maschere per cerchi

Circle template
Trace-cercles



Tirachina
ink-edge
bord anti-tache

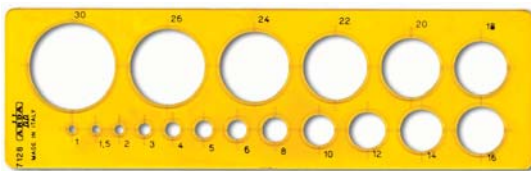
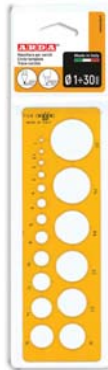

Ref. 7128

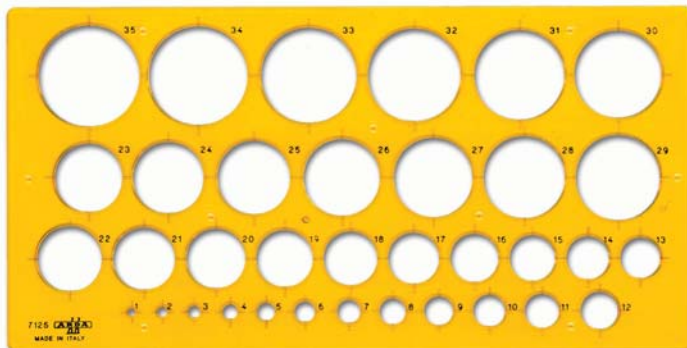

Ref. 7125



Ref. 7126

Art.	EAN13 art.	Descrizione / Description	Dimens. art.	INNER pcs	EAN13 inner	MASTER pcs
7125	8003438071255	mm. 1÷35	247x124 mm	10	8003438171252	200
7126	8003438071262	mm. 1÷55/80	278x141 mm	10	8003438171269	200
7128	8003438071286	mm 1÷30	193x58 mm	10	8003438171283	500

Maschere per ellissi

Ellipses template
Gabarit ellipses



Tirachina
ink-edge
bord anti-tache

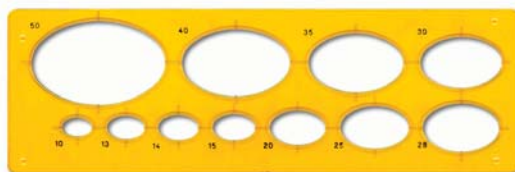
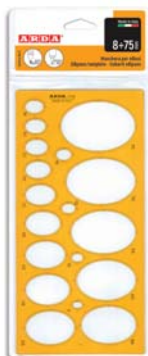

Ref. 7127

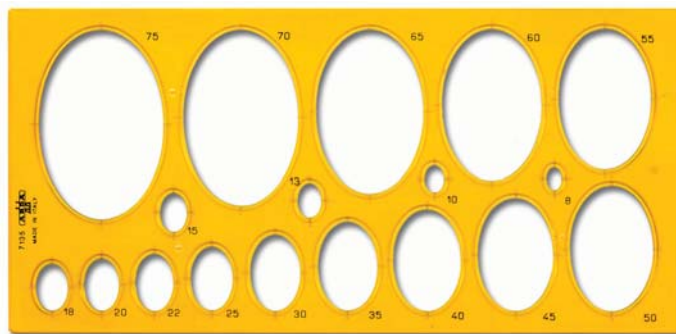

Ref. 7135

Art.	EAN13 art.	Descrizione / Description	Dimens.art.	INNER pcs	EAN13 inner	MASTER pcs
7127	8003438071279	mm. 10÷50	196x63 mm	10	8003438171276	500
7135	8003438071354	mm. 8÷75	270x130 mm	10	8003438171351	200

Maschere per quadri

Templates for squares
Gabarits pour carrés



Tirachina
ink-edge
bord anti-tache

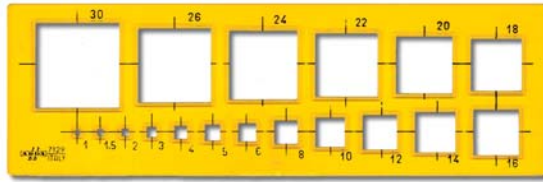

Ref. 7129

Art.	EAN13 art.	Descrizione / Description	Dimens. art.	INNER pcs	EAN13 inner	MASTER pcs
7129	8003438071293	Per quadri mm.1÷30	197x63 mm	10	8003438171290	500

Maschere per arredamento

Templates for decoration
Gabarits pour d'ameublement



Tirachina
ink-edge
bord anti-tache

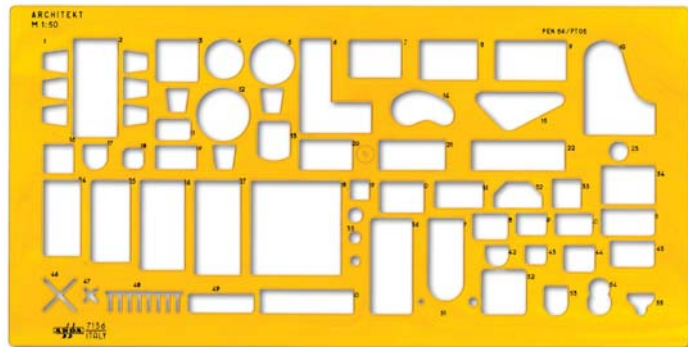

Ref. 7136

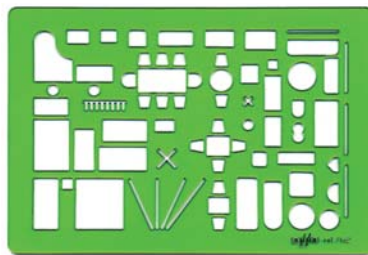

Ref. 7142

Art.	EAN13 art.	Descrizione / Description	Dimens. art.	INNER pcs	EAN13 inner	MASTER pcs
7136	8003438071361	Arredamento scala 1:50		10	8003438171368	10
7142	8003438071422	Arredamento scala 1:100		10	8003438171429	10

Parabola

Parabel - Parabole



Tirachina
ink-edge
bord anti-tache

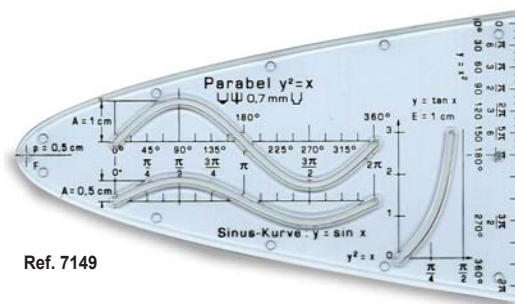

Ref. 7149

Art.	EAN13 art.	Descrizione / Description	Dimens. art.	INNER pcs	EAN13 inner	MASTER pcs
7149	8003438071293	Per quadri mm.1÷30	197x63 mm	10	8003438171290	500

Normografi

Lettering guides
Normographe



Norme UNI - Ref. 30025 - 3 - 35 - 4 - 5 - 6 - 7 - 8 - 10 - 12 - 14



Norme ISO - Ref. 30235 - 5 - 7 - 10



NORME UNI

Art.	EAN13 art.	Descrizione / Description	INNER pcs	EAN13 inner	MASTER pcs
30025	8003438300256	h. caratteri mm.2,5	10	8003438310255	10
3003	8003438030030	h. caratteri mm.3	10	8003438031037	10
30035	8003438300355	h. caratteri mm.3,5	10	8003438310354	10
3004	8003438030047	h. caratteri mm.4	10	8003438031044	10
3005	8003438030054	h. caratteri mm.5	10	8003438031051	10
3006	8003438030061	h. caratteri mm.6	10	8003438031068	10
3007	8003438030078	h. caratteri mm.7	10	8003438031075	10
3008	8003438030085	h. caratteri mm.8	10	8003438031082	10
30010	8003438300102	h. caratteri mm.10	10	8003438310101	10
30012	8003438300126	h. caratteri mm.12	10	8003438310125	10
30014	8003438300140	h. caratteri mm.14	10	8003438311146	10

NORME ISO

Art.	EAN13 art.	Descrizione / Description	INNER pcs	EAN13 inner	MASTER pcs
30235	8003438302359	h. caratt mm.3,5	10	8003438312358	10
3025	8003438303509	h. caratteri mm.5	10	8003438313508	10
3027	8003438303707	h. caratteri mm.7	10	8003438313706	10
30210	8003438303103	h. caratteri mm.10	10	8003438313102	10

Normosfere

Lettering stencils
trace-lettre pour crayon
à bille



ref. 5006 - h. 6 mm



ref. 5008 - h. 8 mm



ref. 5010 - h. 10 mm



PER PENNA
FOR PEN - POUR STYLO

Art.	EAN13 art.	Descrizione / Description	INNER pcs	EAN13 inner	MASTER pcs
5006	8003438500601	6 mm	10	8003438500618	10
5008	8003438500809	8 mm	10	8003438500816	10
5010	8003438050014	10 mm	10	8003438150011	10

PORTAMINE 2 mm

Cluch pencil - Porte-mine

MADE IN ITALY
ITALIAN QUALITY & STYLE

TURNER 4019



Sezione esagonale
Hexagonal section
Section hexagonale

Mina a caduta libera - fermaglio, pulsante e puntale in metallo. Pinza in metallo a 3 morsetti. Affilamine integrato nel pulsante. Mina in gradazione B, Ø 2 mm, lunghezza 90 mm.

With free drop lead - pocket clip, push button and tip in metal. Leads holder with metal jaws clamp. Sharpener integrated in the push button. B grade lead, Ø 2 mm, length 90 mm

Mine à libre chute - clip, bouton poussoir et pointe en métal. Pince à 3 sections en métal. Aiguise-mine intégré dans le bouton poussoir. Mine grade B, Ø 2 mm, longueur 90 mm.

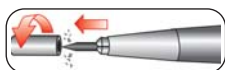

Ref. 4019PBAR - 20 pcs

Art.	EAN13 art.	Descrizione / Description	INNER	EAN13 inner	MASTER
4019PBAR	8003438030719	Barattolo 20 portamine 2 mm pastel (ean pcs 8003438 031402)	1	8003438030719	10

PORTAMINE 2 mm

Cluch pencil - Porte-mine

MADE IN ITALY
ITALIAN QUALITY & STYLE

TURNER 4019



Sezione esagonale
Hexagonal section
Section hexagonale

Mina a caduta libera - fermaglio, pulsante e puntale in metallo. Pinza in metallo a 3 morsetti. Affilamine integrato nel pulsante. Mina in gradazione B, Ø 2 mm, lunghezza 90 mm.

With free drop lead - pocket clip, push button and tip in metal. Leads holder with metal jaws clamp. Sharpener integrated in the push button. B grade lead, Ø 2 mm, length 90 mm

Mine à libre chute - clip, bouton poussoir et pointe en métal. Pince à 3 sections en métal. Aiguise-mine intégré dans le bouton poussoir. Mine grade B, Ø 2 mm, longueur 90 mm.



Ref. 4019BL6 - Blister



Ref. 4019CART
Cartella / Folder / Dossier
12 pz/pcs



Ref. 4019COLESP
Display "Multicolour" - 12 pz/pcs

Art.	EAN13 art.	Descrizione / Description	INNER	EAN13 inner	MASTER
4019CART	- - -	Portamine 2 mm in cartella da 12 pz. (ean pcs 8003438 040190)	12	8003438010018	72
4019COLESP	8003438018045 (Ean display)	Display 12 pz / pcs "Multicolours" (ean pcs 8003438 040190)	1	8003438018045	10 display
4019BL6	8003438640192	Portamine 2 mm + tubetto 6 mine 2 mm in blister	20	8003438840196	20

PORTAMINE 2,0 mm

Clutch pencil - Porte-mine

TURNER 5025 METAL



Sezione esagonale
Hexagonal section
Section hexagonale

Mina ad avanzamento frenato.

Fusto, fermaglio, pulsante e puntale in metallo.

Affilamine integrato nel pulsante. Mina in gradazione HB, Ø 2 mm.

Push mechanism. Barrel, pocket clip, push button and tip in metal. Leads holder with metal jaws clamp. Sharpener integrated in the push button. HB grade lead, Ø 2 mm.

Mines avec avance automatique. Corp, clip, bouton poussoir et pointe en métal.

Aiguise-mine intégré dans le bouton poussoir.

Mine grade HB, Ø 2 mm.



Ref. 5025ESP - Display 12 pcs

Art.	EAN13 art.	Descrizione / Description	INNER	EAN13 inner	MASTER
5025ESP	8003438033918 (ean display)	Display n.12 pz. (ean pcs 8003438 033383)	1	8003438033918	10 (display)

PORTAMINE max 2,8 mm

Clutch pencil - Porte-mine

DIAMANT 5024



Sezione ottagonale
Octagonal section
Section octogonale

Mina a caduta libera. Fermaglio, pulsante

e puntale in metallo. Pinza a 4 morsetti.

Impugnatura antiscivolo in metallo. Affilamine integrato nel pulsante. Mina in gradazione B, Ø 2 mm, lunghezza 90 mm

Free drop lead. Pocket clip, push button and tip in metal. Leads holder 4 metal jaws clamp. Non-slip metal grip zone. Sharpener integrated in the push button. B grade lead, Ø 2 mm, length 90 mm

Mines à chute libre. Clip, bouton poussoir et pointe en métal. Pince à 4 sections en métal. Zone de préhension en métal. Aiguise-mine intégré dans le bouton poussoir. Mine grade B, Ø 2 mm, longueur 90 mm.

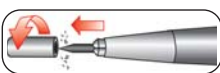

MADE IN ITALY
ITALIAN QUALITY & STYLE



Ref. 5024BL6 - Blister



Ref. 5024CART
Cartella / Folder / Dossier
12 pz/pcs

Art.	EAN13 art.	Descrizione / Description	INNER	EAN13 inner	MASTER
5024CART	8003438050243	Portamine fino a 3 mm in cartella da 12 pz.	12	8003438009975	72
5024BL6	8003438650245	Portamine fino a 3 mm + tubetto 6 mine 2 mm in blister	20	8003438850249	20

PORTAMINE 2,0 mm

Cluch pencil - Porte-mine

TURNER 4015

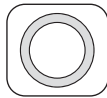

Sezione tonda
Round section
Section ronde

Mina a caduta controllata - puntale in metallo. Affilamine integrato nel pulsante.
Mina in gradazione HB, Ø 2 mm.

Clutch pencil with spring-guided lead - tip made of metal. Sharpener integrated in the push button. HB grade lead, Ø 2 mm.

Porte-mine avec avancement automatique - pointe en métal.
Aiguise-mine intégré dans le bouton poussoir. Mine grade HB, Ø 2 mm.



Ref. 4015BL6



Ref. 4015ESP - Display 24 pcs

Art.	EAN13 art.	Descrizione / Description	INNER	EAN13 inner	MASTER
4015ESP	8003438033406 (ean display)	Display n.24 pz. (ean pcs 8003438 033376)	1	8003438033406	8 (display)
4015BL6	8003438033390	Portamine 2,00 mm + tubetto 6 mine in blister	20	8003438033413	20

PORTAMINE 2,0 mm

Cluch pencil - Porte-mine

TURNER 4017

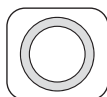

Sezione tonda
Round section
Section ronde

Mina a caduta controllata - fermaglio e puntale in metallo. Finitura soft-touch del fusto.

Clutch pencil with spring-guided lead - clip and tip made of metal. Soft-touch finish of the barrel.

Porte-mine avec avancement automatique - clip et pointe en métal. Soft-touch finition.



Ref. 4017BL6

Art.	EAN13 art.	Descrizione / Description	INNER	EAN13 inner	MASTER
4017BL6	8003438020840	Portamine 2 mm + tubetto 6 mine 2 mm in blister	20	8003438020857	20

PORTAMINE 0,7 mm

Clutch pencil - Porte-mine

MAXIGOMMA 913

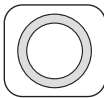

Sezione tonda
Round section
Section ronde

Impugnatura ergonomica in gomma antiscivolo removibile. Mina a caduta controllata. Maxi gomma lunghezza cm.4 - Ø 6 mm. che fuoriesce con meccanismo a rotazione.

Ergonomic grip in no sliding rubber removable. Clutch pencil with spring-guided lead.

Maxi rubber length 4 cm - Ø 6 mm. which comes out with a rotating mechanism.

Prise en main ergonomique en gomme anti-dérapant amovible. Porte-mine avec avancement automatique. Maxi gomme longueur 4 cm - Ø 6 mm. qui sort avec un mécanisme de rotation.



Ref. 913ESP - Display 12 pcs

Art.	EAN13 art.	Descrizione / Description	INNER	EAN13 inner	MASTER
913ESP	8003438033956 (ean display)	Display n.12 pz. (ean pcs 8003438 033444)	1	8003438033956	10 (display)

PORTAMINE 0,7 mm

Clutch pencil - Porte-mine

LANCASTER 912

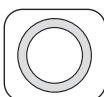

Sezione tonda
Round section
Section ronde

Impugnatura ergonomica in gomma antiscivolo removibile. Mina a caduta controllata.

Ergonomic grip in no sliding rubber removable. Clutch pencil with spring-guided lead.

Prise en main ergonomique en gomme anti-dérapant amovible. Porte-mine avec avancement automatique.



Ref. 912BL12



Ref. 912ESP - Display 24 pcs

Art.	EAN13 art.	Descrizione / Description	INNER	EAN13 inner	MASTER
912ESP	8003438020123 (ean display)	Display n.24 pz. (ean pcs 8003438 020093)	1	8003438020123	4 (display)
912BL12	8003438021793	Portamine 0,7 mm + tubetto 12 mine in blister	20	8003438021816	20

PORTAMINE 0,5 mm

Clutch pencil - Porte-mine

LANCASTER 903



Sezione triangolare
Triangular section
Section triangulaire

Mina a caduta controllata.

Fermaglio, pulsante e puntale in metallo.

Impugnatura ergonomica.

Clutch pencil with spring-guided lead.

Clip, push button and tip made of metal.

Ergonomic handle

Porte-mine avec avancement automatique.

Clip et pointe en métal.

Poignée ergonomique



Gommino incorporato
Eraser incorporated
Gomme incorporée



Ref. 903BL12



Ref. 903ESP - Display 12 pcs

Art.	EAN13 art.	Descrizione / Description	INNER	EAN13 inner	MASTER
903ESP	8003438020116 (ean display)	Display n.12 pz. (ean pcs 8003438 020086)	1	8003438020116	10 (display)
903BL12	8003438021786	Portamine 0,5 mm + tubetto 12 mine 0,5 mm in blister	20	8003438021809	20

MINE

Leads - Mines

2.0 mm B

n.6 mine graduazione B nere
Ø 2 mm - lunghezza 90 mm

n. 6 leads in B grade, black
Ø 2 mm - 90 mm. long.

no. 6 mines - dureté B, noir
Ø 2 mm. - Longueur 90 mm.



Ref. 5030

Ref. 5030BL

Art.	EAN13 art. 8003438...	Descrizione / Description	INNER	EAN inner 8003438...	MASTER
5030	...150301	tub. 6 mine in barattolo da 15 pz.	15	...050304	180
5030BL	...503008	n.1 tub. 6 mine in busta	20	...703002	20

MINE

Leads - Mines

0.5 - 0.7 mm HB



ref. 503105

ref. 503107

Art.	EAN13 art. 8003438...	Descrizione / Description	INNER	EAN inner 8003438...	MASTER
503105	...020598	tub.12 mine 0,5 mm HB	12	...020628	12
503107	...020604	tub.12 mine 0,7 mm HB	12	...020635	12

RASCHIETTO AFFILAMINE

Sandpaper scraper for leads
Recloir pour aguiser les mines

Per affilare le mine. 10 foglietti di ricambio (2 grammature) e spugna per pulire la mina.

To sharpen mine. 10 sheets for replacement (2 weights) and sponge to clean the mines.

Pour aiguiser la mine. 10 feuilles de replacement (2 poids) et une éponge pour nettoyer la mine.



Ref. 909

CUSTODIA SALVA-SPORCO : evita la fuoriuscita dei residui proteggendo fogli e cartella
DIRT-SAVING CASE: prevents the escape of residues by protecting sheets and folders
BOÎTIER ANTI-DIRT: empêche les résidus de s'échapper, protégeant les feuilles et le dossier

Art.	EAN13 art.	Descrizione / Description	INNER pcs	EAN13 inner	MASTER pcs
909	8003438014795	Raschietto affilamine	20	8003438014801	200

AFFILAMINE A CAMPANA

Rotary lead pointer
Taille-crayon roulant

Temperamine a rotazione per mine con Ø 2 mm. Consente due tipi di affilatura: una a punta rotonda, smussata per il disegno a mano libera e la scrittura, e una appuntita ad ago, ideale per il disegno tecnico e di precisione. Spugna per pulire la mina.

Rotary sharpener for mines Ø 2 mm. It allows two types of sharpening: one with a round tip, suitable for freehand drawing and writing, and one pointed tip, suitable for technical and precision drawing. Sponge to clean the mine.

taille-crayon roulant pour mines Ø 2 mm. Pour deux types d'affûtage: l'un avec pointe ronde biseauté pour dessiner et écrire, et une pointue, idéale pour les dessins techniques et précis. Éponge pour nettoyer la mine.



Ref. TE809

Art.	EAN13 art.	Descrizione / Description	INNER pcs	EAN13 inner	MASTER pcs
TE809	8003438026217	Temperamine a campana	6	8003438026224	414

INNOVATION

ARDA ha ripensato in modo totalmente innovativo alla confezione del compasso. L'obiettivo era risolvere il problema delle confezioni dei compassi che si rompono o si aprono nello zaino. Il risultato sono 2 concept :

L'ASTUCCIO STAND-UP e la SMART BOX.

ARDA has rethought the compass packaging in a totally innovative way. The goal was to solve the problem of compass packaging that breaks or opens in the backpack. The result is 2 concepts: the STAND-UP CASE and the SMART BOX.

ARDA a repensé le packaging du compas de manière totalement innovante. L'objectif était de résoudre le problème de la rupture ou de l'ouverture de la boîte dans le sac à dos. Le résultat est 2 concepts : le STAND-UP CASE et la SMART BOX.

ASTUCCIO STAND-UP



Astuccio in nylon con chiusura a cerniera per custodire il compasso e tutti gli accessori. Lo apri, lo pieghi, lo appoggi sul banco e hai tutto a portata di mano. Una volta terminato il lavoro richiudi l'astuccio e lo riponi nello zaino. Il compasso e gli accessori rimangono protetti e non rischiano di fuoriuscire.

Nylon case with zipper closure to store the compass and all the accessories. Open it, fold it, place it on the desk and you have everything at hand. Once the work is finished, close the case and put it in the backpack. The compass and the accessories remain protected and do not risk falling out.

Étui en nylon avec fermeture zippée pour ranger le compas et tous les accessoires. Vous l'ouvrez, le pliez, le posez sur le comptoir et vous avez tout à portée de main. Une fois le travail terminé, fermez la boîte et mettez-le dans votre sac à dos. Le compas et les accessoires restent protégés et ne risquent pas de tomber.

SMART BOX



Scatola in plastica INFRANGIBILE per custodire il compasso e tutti gli accessori. Il coperchio si ruota e la scatola diventa supporto per il compasso e i suoi accessori. La appoggi sul banco aperta e hai tutto a portata di mano. Una volta terminato il lavoro richiudi la scatola e la riponi nello zaino. Il compasso e gli accessori rimangono protetti e non fuoriescono. La scatola è infrangibile e non rischia di rompersi.

UNBREAKABLE plastic box to store the compass and all the accessories. The lid rotates and the box becomes a support for the compass and its accessories. You place it open on the desk and you have everything at hand. Once you have finished your work, close the box and put it in your backpack. The compass and accessories remain protected and do not fall out. The box is unbreakable and if it falls it does not risk breaking.

Boîte en plastique INCASSABLE pour ranger le compas et tous les accessoires. Le couvercle tourne et la boîte devient support pour le compas. Vous le placez ouvert sur le comptoir et avez tout à portée de main. Une fois le travail terminé, fermez la boîte et mettez-la dans votre sac à dos. Le compas rest protégé. La boîte est incassable et ne se brisera pas en cas de chute.

Balaustrone in metallo con frizione e prolunga

Metal quick-set compass with push-button and arm
Balustré avec réglage rapide et rallonge en métal

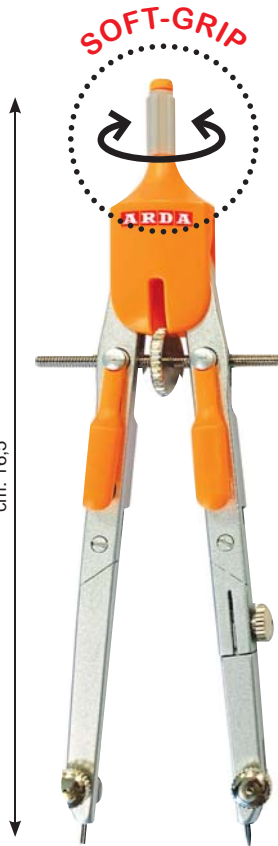

6 pcs
Ref. CO1ESP
23 x 16 x 23 h. cm

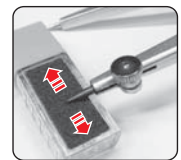
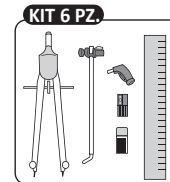

Art.	EAN13 art.	Descrizione / Description	INNER	EAN13 inner	MASTER
CO1ESP	8003438025869	Display 6 pz/pcs: n.3 Fluo (ean 8003438 025852) + n.3 Pastel (ean 8003438 025845)	1	8003438025869	1

Balaustrone in metallo con frizione e prolunga

Metal quick-set compass with push-button and arm
Balustré avec réglage rapide et rallonge en métal



3 pcs
24 x 18 x 39 h. cm

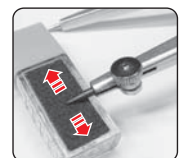
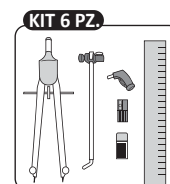

ASTE CON FINITURA SATINATA
RODS WITH SATIN FINISH
BRANCHES AVEC FINITION SATINÉE

Art.	EAN13 art.	Descrizione / Description	INNER	EAN13 inner	MASTER
CO1EL	8003438030672	in display 3 pz/pcs (ean display 800343 030689)	3	8003438030689	3

Balastrone in metallo con frizione e prolunga

Metal quick-set compass with push-button and arm
Balustre avec réglage rapide et rallonge en metal



12 pcs
Ref. CO2ESP
23 x 16 x 23 h. cm

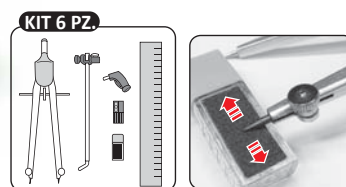
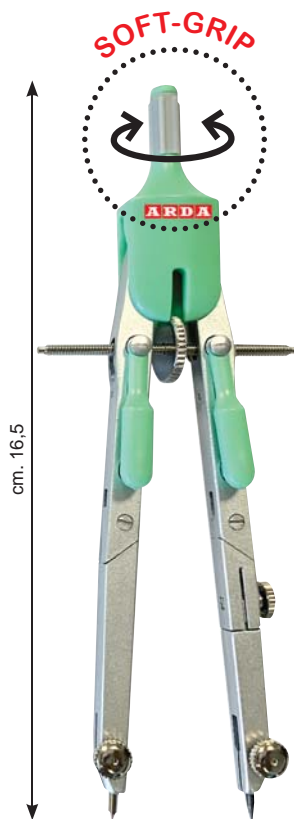

Art.	EAN13 art.	Descrizione / Description	INNER	EAN13 inner	MASTER
CO2ESP	8003438025890	Display 12 pz/pcs: n.6 Fluo (ean 8003438 025883) + n.6 Pastel (ean 8003438 025876)	1	8003438025890	1

Balastrone in metallo con frizione e prolunga

Metal quick-set compass with push-button and arm
Balustre avec réglage rapide et rallonge en metal



12 pcs
Ref. CO2REESP
23 x 16 x 23 h. cm



Articoli ecosostenibili in
PLASTICA RICICLATA
RECYCLED PLASTIC

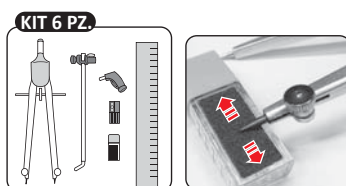

ASTE CON FINITURA SATINATA
RODS WITH SATIN FINISH
BRANCHES AVEC FINITION SATINÉE

Art.	EAN13 art.	Descrizione / Description	INNER	EAN13 inner	MASTER
CO2REESP	8003438029577	Display 12 pz/pcs (ean smart-box 8003438 029584)	1	8003438029577	1

Balastrone in metallo con frizione

Metal quick-set compass with push-button

Balustre avec réglage rapide en metal



12 pcs

Ref. CO3ESP
23 x 16 x 23 h. cm

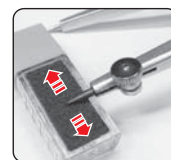
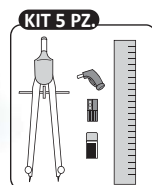

Art.	EAN13 art.	Descrizione / Description	INNER	EAN13 inner	MASTER
CO3ESP	8003438025920	Display 12 pz/pcs: n.6 Fluo (ean 8003438 025913) + n.6 Pastel (ean 8003438 025906)	1	8003438025920	1

Balastrone in metallo aste fisse

Metal quick-set compass

Balustre en metal

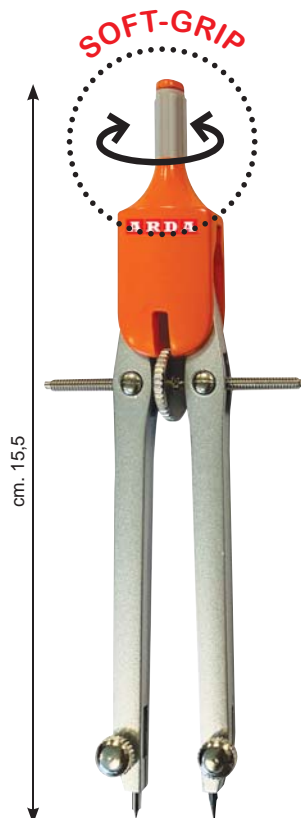

12 pcs

Ref. CO4ESP
23 x 16 x 23 h. cm

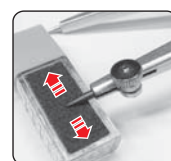
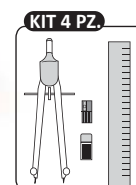

Art.	EAN13 art.	Descrizione / Description	INNER	EAN13 inner	MASTER
CO4ESP	8003438025944	Display 12 pz/pcs (ean smart-box 8003438025937)	1	8003438025944	1

Balaustrino in metallo con apertura rapida

Metal small quick-set compass - Petit balustre en metal, ouverture rapide

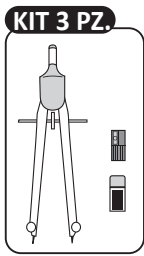

Art.	EAN13 art.	Descrizione / Description	INNER pcs	EAN13 inner	MASTER pcs
CO6FLU	8003438025975	kit 3 pz/pcs in box	12	8003438026071	48

colori assortiti - assorted colours - couleurs assorties

Compassino 1 snodo

School compass - Compass

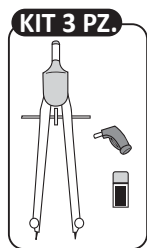

Art.	EAN13 art.	Descrizione / Description	INNER pcs	EAN13 inner	MASTER pcs
CO7FLU	8003438025982	kit 3 pz/pcs in box	12	8003438026071	48

colori assortiti - assorted colours - couleurs assorties

Ricambi per compasso

Spare parts for compass - Accessoires de compas

- 10x Mine per compasso / compass leads / Mines HB - Ø 2 mm
- 1x Temperamine / leads sharpener / Taille-crayons



ref.COMIN

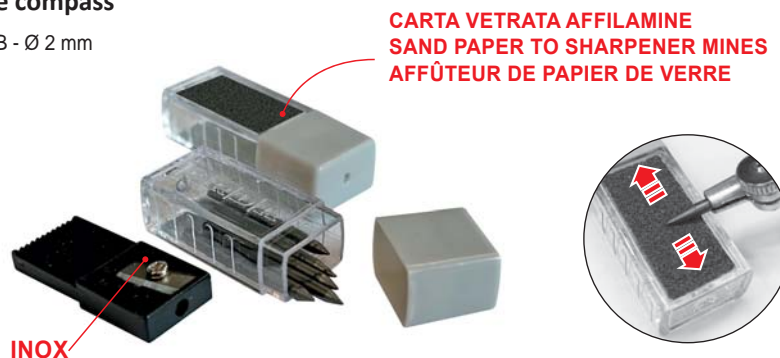

Art.	EAN13 art.	Descrizione / Description	INNER pcs	EAN13 inner	MASTER pcs
COMIN	8003438031648	in blister	20	8003438031655	400

Espositore da terra in cartone
 Carton floor display - Presentoir au sol en carton

66
 pcs

Ref. 500CO1



6x ref.CO1AS
 Balastrone in metallo con frizione e prolunga
 Metal quick-set compass with push-button and arm
 Balustre avec réglage rapide et rallonge en metal

Kit 6 pz./pcs
 in stand-up
 col.ass. FLUO e PASTEL



12x ref. CO2AS
 Balastrone in metallo con frizione e prolunga
 Metal quick-set compass with push-button and arm
 Balustre avec réglage rapide et rallonge en metal

Kit 6 pz. - in smart-box
 col. ass. FLUO e PASTEL



12x ref. CO3AS
 Balastrone in metallo con frizione
 Metal quick-set compass with push-button
 Balustre avec réglage rapide en metal

kit 5 pz. - in smart-box
 col. ass. FLUO e PASTEL



12x CO4FLU
 Balastrone in metallo aste fisse
 Metal quick-set compass
 Balustre en metal

kit 4 pz. - in smart-box
 col. ass. FLUO



12x ref. CO2RE
 Balastrone in metallo con frizione e prolunga
 Metal quick-set compass with push-button and arm
 Balustre avec réglage rapide et rallonge en metal

BLACK IS THE NEW GREEN

kit 6 pz. - in smart-box



12x CO7FLU
 Compassino in metallo 1 snodo
 School compass
 Compass

in scatola / in box
 col.ass. FLUO



DISEGNO
 DRAWING

Art.	EAN13 art.	Descrizione / Description	INNER	MASTER
500CO1	8003438028204	Display 66 pz. / pcs	1	1

Disponibilità limitata alle campagne promozionali - Product availability limited to promotional campaigns - Disponibilité limitée aux campagnes promotionnelles

Tubi portadisegni **IN PLASTICA**

Plastic tubes for drawings
Tubes pour dessins en plastique



ref. 1543/72N



Estensibili a 2 moduli. Blocco per diversi formati di foglio. Tappo a vite. Tracolla regolabile. Etichetta per nome.
Telescopic 2 components. Blocking for various sizes. Screw cap. Adjustable belt. Label for name.
Extensible à 2 éléments. blocage pour formats différents. Couvercle à vis. Bandoulière réglable.
Etiquette pour nom.

Art.	EAN13 art.	Descrizione / Description	INNER pcs	EAN13 inner	MASTER pcs
1543N	8003438015334	SMALL nero con tappo col. ass. / black with ass.col.cap / noir avec couvercle coul.ass.	12	8003438015419	12
1572N	8003438015402	XL nero con tappo col. ass. / black with ass.col.cap / noir avec couvercle coul.ass.	12	8003438015426	12
1543/72N	8003438016058	Display 14 pz : n.8 SMALL col. ass. + n.6 XL col. ass.	1	8003438016058	1

Tavoletta per disegno (parallelografi)

Drawing boards (parallelograph)
Tables à dessin (parallélographe)

SCORRIMENTO A FILO.
SLIDING WITH THREAD.
GLISSEMENT À FIL.



Con leggio
with stand - avec lutrin



Art.	EAN13 art.	F.to / size	INNER	EAN13 inner	MASTER
050M	8003438014153	cm.40x53	1	8003438014153	8
060M	8003438014207	cm.48x63	1	8003438014207	7
070M	8003438014214	cm.50x73	1	8003438014214	5

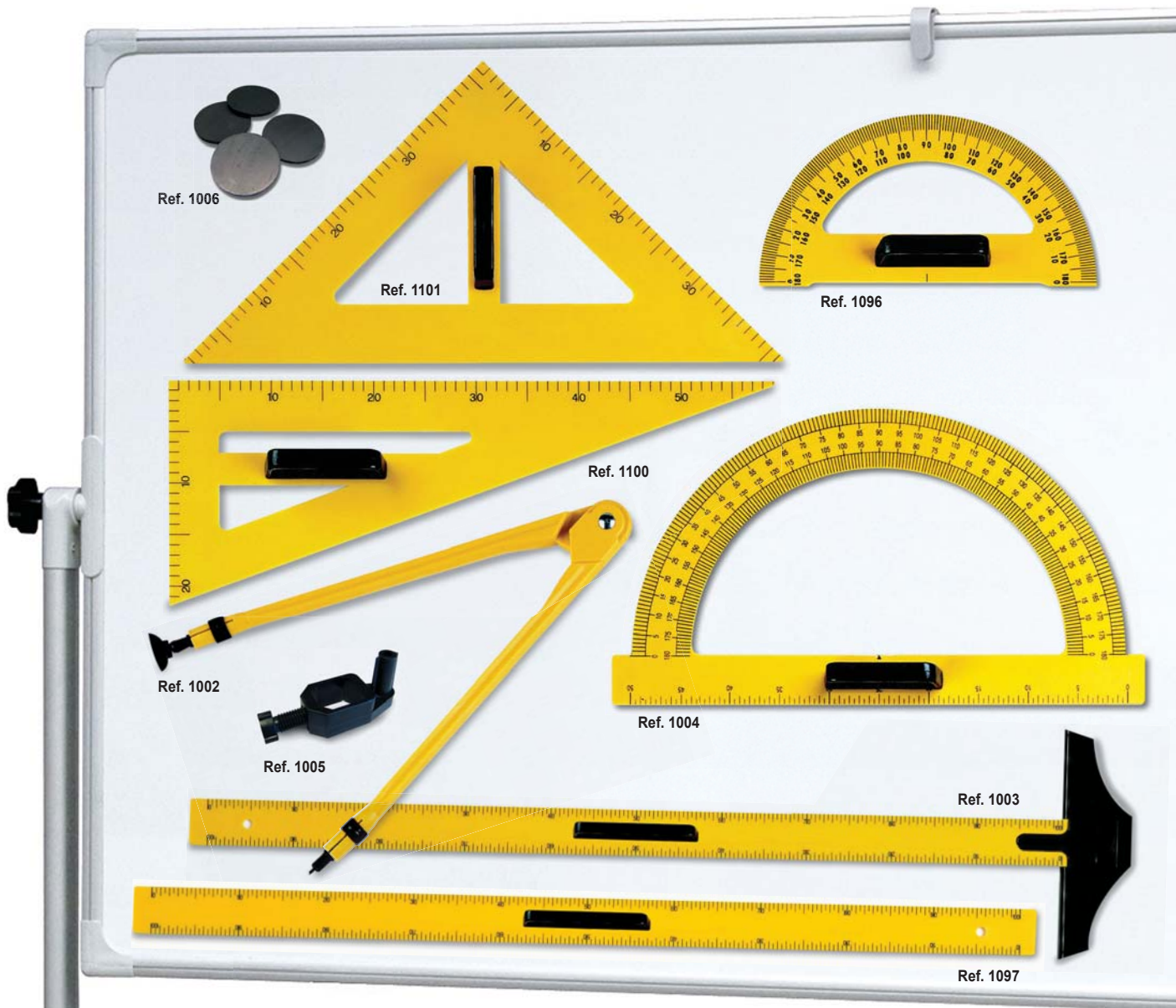

in plastica - in plastic - en plastique



Art.	EAN13 art.	Descrizione / Description	INNER	EAN13 inner	MASTER
1100	8003438011008	Squadra / set square / equerre 70° cm. 60	1	8003438011008	50
1101	8003438011015	Squadra / set square / equerre 45°cm. 60	1	8003438011015	50
1096	8003438010964	Goniometro / protractor / rapporteur 180° cm.35	1	8003438010964	50
1004	8003438010049	Goniometro / protractor / rapporteur 180° cm.50	1	8003438010049	50
1097	8003438010971	Riga / ruler / règle cm. 100	1	8003438010971	25
1003	8003438010032	Riga T / T ruler / règle "T" cm.100	5	8003438031730	5
1002	8003438010025	Compasso / compass / compas cm. 35	1	8003438010025	5
1005	8003438010056	Adattatore per compasso compass adaptor / adaptateur pour compas	1	8003438010056	50
1006	8003438010063	Set 4 calamite / set 4 magnets / set 4 aimants	20	8003438110060	20



STRUMENTI PER IL CARTEGGIO NAUTICO.

EQUIPMENT FOR NAUTICAL CARTOGRAPHY
INSTRUMENTS POUR LES MAPPE DE NAVIGATION.

MADE IN ITALY

ITALIAN QUALITY & STYLE

Set per carteggio nautico

Nautical set - Set pour nautique



ref. 424

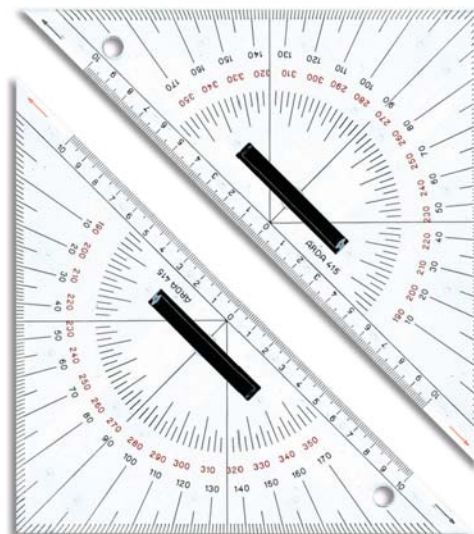

**PREGIATA E RESISTENTE
BUSTA CON CHIUSURA
MAGNETICA**

**HIGH-QUALITY AND
RESISTANT ENVELOPE
WITH MAGNETIC
CLOSURE**

**ENVELOPPE DE HAUTE
QUALITÉ ET RÉSISTANTE
AVEC FERMETURE
MAGNÉTIQUE**

Art.	EAN13 art.	Descrizione / Description	INNER pcs	EAN13 inner	MASTER pcs
424	8003438016041	Set 4 pz : 2x squadre nautiche cm.26 ref. 415 1x compasso nautico in zama in custodia sing. ref.420 1x portamine 0,5 ref.903	1	8003438016041	3

Compasso nautico

Nautical compass - Compas nautique

Compasso in zama

Zama compass - Compas de zama

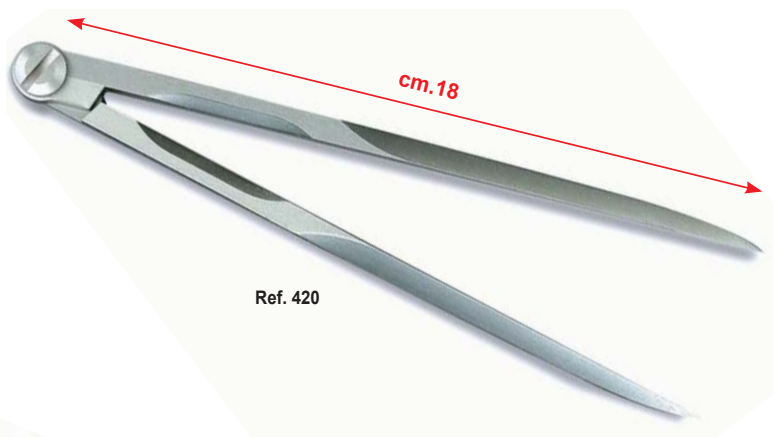

Ref. 420

Art.	EAN13 art.	Descrizione / Description	INNER pcs	EAN13 inner	MASTER pcs
420	8003438420008	Compasso nautico	1	8003438420008	10

Squadre nautiche 45° 26 cm

Set square 45° 26 cm
Equerres 45° 26 cm

plexiglas



PACKAGING x ref. 415 - 416 - 417

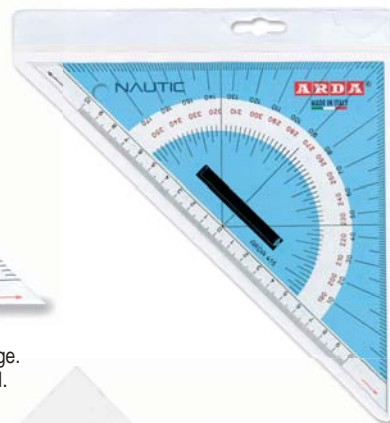
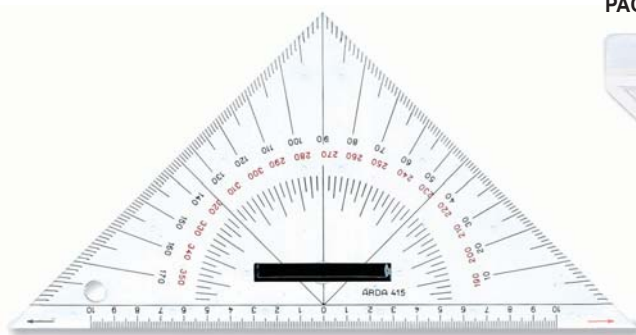

Ref. 415 Con pomolo e millimetratura con linea di fede.
With grip, graduated with hypotenuse scale detached from edge.
Avec poignée et graduation hypotenuse détachée du bord.

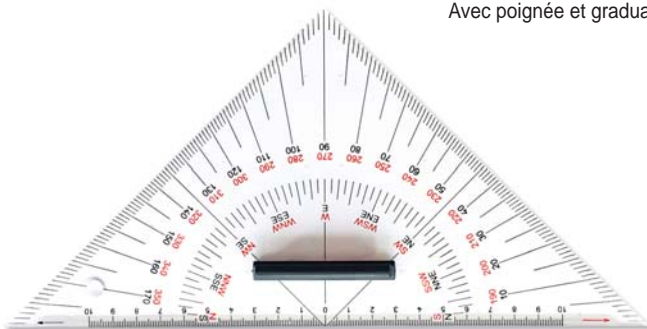

Ref. 416 Con pomolo, millimetratura con linea di fede sul bordo
With grip, graduated with hypotenuse scale on the edge.
Avec poignée et graduation hypotenuse sur le bord.



Ref. 417 Neutra con pomolo
Without graduation, with handle
Non-graduée, avec poignée

Art.	EAN13 art.	Descrizione / Description	INNER pcs	EAN13 inner	MASTER pcs
415	8003438415004	45° cm.26	10	8003438415011	10
416	8003438416001	45° cm.26	10	8003438416018	10
417	8003438417008	45° cm.26	10	8003438417015	10

Squadre nautiche 45° 32 cm

Set square 45° 32 cm
Equerres 45° 32 cm

plexiglas

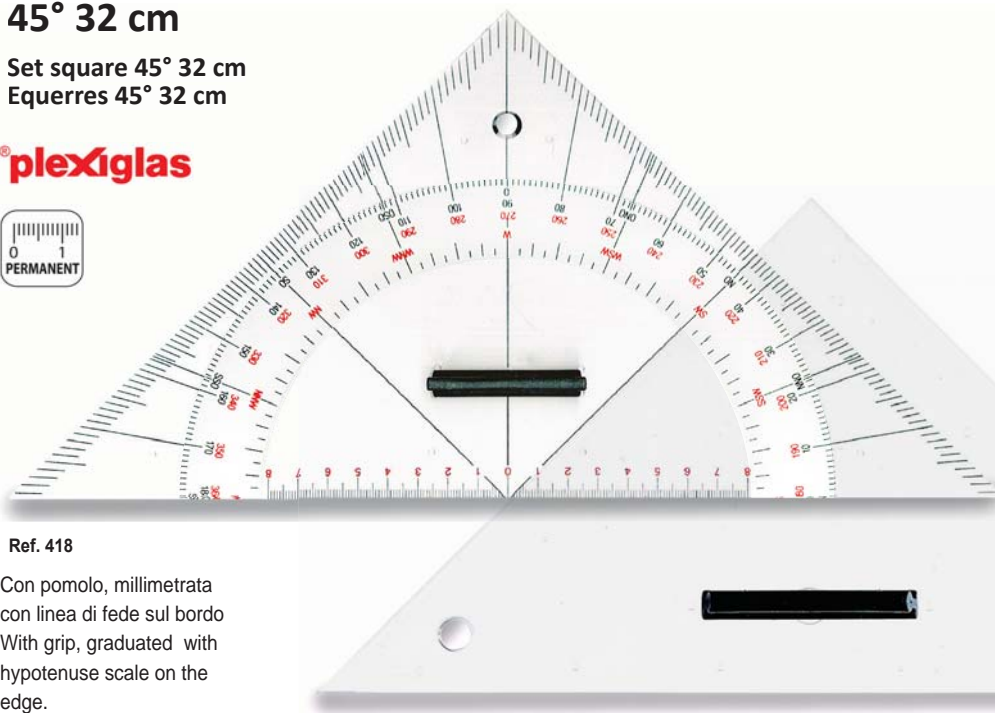

Ref. 418

Con pomolo, millimetratura con linea di fede sul bordo
With grip, graduated with hypotenuse scale on the edge.
Avec poignée et graduation hypotenuse sur le bord.

Ref. 419

Neutra con pomolo
Without graduation, with handle.
Non-graduée, avec poignée

Art.	EAN13 art.	Descrizione / Description	INNER pcs	EAN13 inner	MASTER pcs
418	8003438418005	45° cm.32	10	8003438418012	10
419	8003438419002	45° cm.32	10	8003438419019	10

Goniometri
Protractor - Rapporteur

plexiglas

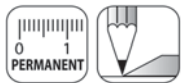

Smusso e bordo interno
Bevelled edge and finger lift
Facette et bord intérieur

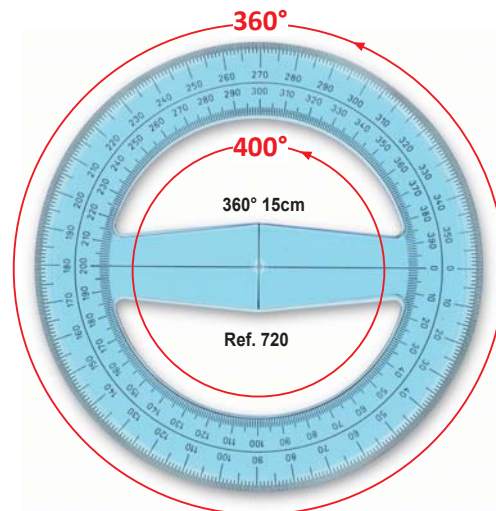
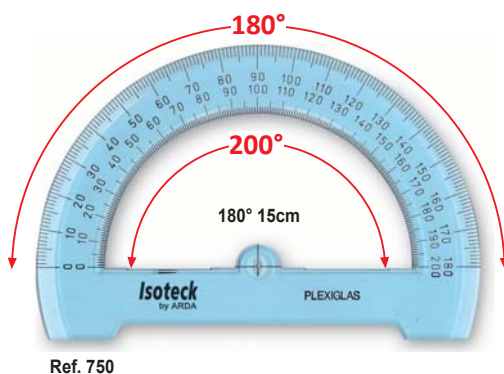

Art.	EAN13 art.	Descrizione / Description	INNER pcs	EAN13 inner	MASTER pcs
750	8003438007506	180° cm. 15	10	8003438107503	10
720	8003438007209	360° cm. 15	10	8003438107206	10

Righe a rullo

Rolling ruler
Règle roulante

plexiglas

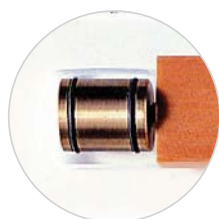

Ref. 328

Rulli in ottone con gomma antiscivolo - Brass roller with no-sliding rubber - Rouleau en laiton avec gomme antidérapant

Art.	EAN13 art.	Descrizione / Description	INNER pcs	EAN13 inner	MASTER pcs
328	8003438328014	cm. 40	1	8003438328014	1

Righe parallele

Parallel rulers
Règles parallèles



Ref. 325SC

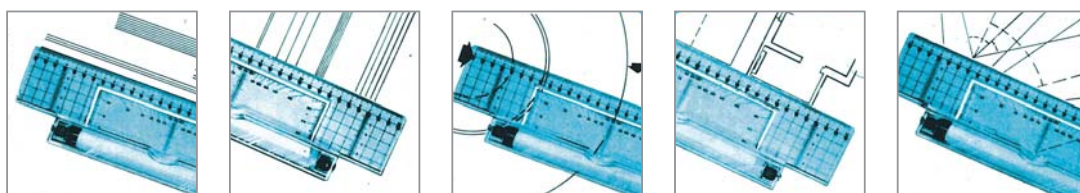

Art.	EAN13 art.	Descrizione / Description	INNER pcs	EAN13 inner	MASTER pcs
325SC	8003438325006	cm.30	1	8003438325006	5